

TECHNICAL MANUAL

**OPERATOR AND ORGANIZATIONAL MAINTENANCE  
MANUAL INCLUDING REPAIR PARTS AND  
SPECIAL TOOL LISTS  
TEST SETS, TELEGRAPH**

**AN/GGM-15 (V) 1**

**(NSN 6625-00-464-1702)**

**AN/GGM-15 (V) 2**

**(NSN 6625-00-442-6131)**

This copy is a reprint which includes current pages from Change 1. The title was changed by Change 1.

---

HEADQUARTERS DEPARTMENT OF THE ARMY

NOVEMBER 1970

**WARNING**

Be careful when working on the 115-volt ac line connections. Serious injury or death may result from contact with these terminals.

**DON'T TAKE CHANCES!**

EXTREMELY DANGEROUS VOLTAGES EXIST IN THE FOLLOWING UNIT:

OSCILLOSCOPE ..... 1800 volts



**Operator and Organizational Maintenance Manual Including  
Repair Parts and Special Tool Lists**

**TEST SETS, TELEGRAPH AN/GGM-15 (V)1  
AND ANG/GGM-15 (V)2**

	Paragraph	Page
CHAPTER 1.	INTRODUCTION	
Section I.	General	
	Scope.....	1-1 1-1
	Indexes of publications .....	1-2 1-1
	Forms and records .....	1-3 1-1
	II. Description and Data	
	Purpose and use .....	1-4 1-4
	Description of major components .....	1-5 1-4
	Technical characteristics .....	1-6 1-9
CHAPTER 2.	INSTALLATION	
	General .....	2-1 2-1
	Unpacking .....	2-2 2-1
	Checking unpacked equipment .....	2-8 2-1
	Reference designations .....	2-4 2-5
	Shelter requirements .....	2-6 2-6
	Tools and test equipment required for installation .....	2-6 2-6
	Installation.....	2-7 2-6
	External equipment connections .....	2-8 2-7
	Installation of fuses and crystals.....	2-9 2-10
	Initial adjustments .....	2-10 2-10
CHAPTER 3.	OPERATION	
Section I.	Operating Controls and Indicators	
	General 1-4 .....	3-1 3-1
	Generator front panel controls, indicators, and connectors 1-4.....	3-2 3-1
	Analyzer front panel controls indicators and connectors 1-4.....	3-3 3-3
	Oscilloscope front panel controls and indicators 1-4 .....	3-4 3-4
	II. Operating Procedures	
	General .....	3-5 3-6
	Types of distortion.....	3-6 3-6
	Generator operating procedures .....	3-7 3-8
	Analyzer operating procedures.....	3-8 3-14
	Oscilloscope operating procedures .....	3-9 3-19
	Stopping and shutdown procedures.....	3-10 3-12
	III. Operation Under Unusual Conditions	
	General .....	3-11 3-21
	Operation in arctic climate.....	3-12 3-22
	Operation in tropical climates .....	3-13 3-22
	Operation in desert climates.....	3-14 3-22

\*This manual supersedes TM 11-6625-1668-12, 7 July 1969.

	Paragraph	Page
CHAPTER 4	MAINTENANCE	
	Scope of maintenance .....	4-1 4-1
	Tools, materials, and test equipment required.....	4-2 4-1
	Operator's preventive maintenance.....	4-3 4-1
	Preventive maintenance checks and services periods .....	4-4 4-1
	Daily preventive maintenance cheeks and services .....	4-6 4-1
	Weekly preventive maintenance checks and services.....	4-6 4-2
	Quarterly preventive maintenance cheeks and services.....	4-7 4-3
	Analyzer self-test (error test mode) .....	4-8 4-4
	Cleaning, painting, and preservation.....	4-9 4-4
	Troubleshooting procedure .....	4-10 4-5
	Troubleshooting chart.....	4-11 4-5
CHAPTER 5.	SHIPMENT, LIMITED STORAGE, AND DEMOLITION TO PREVENT ENEMY USE	
Section I.	Shipment and Limited Storage Dissassembly of equipment .....	5-1 5-1
	Repackaging for shipment or limited storage .....	5-2 5-1
Section II.	Demolition of Material to Prevent Enemy Use	
	Authority for demolition.....	5-3 5-1
	Methods of destruction .....	5-4 5-2
APPENDIX A.	REFERENCES.....	A-1
	B. MAINTENANCE ALLOCATION.....	B-1
	C. ORGANIZATIONAL REPAIR PARTS AND SPECIAL TOOL LISTS .....	C-1

**LIST OF ILLUSTRATIONS**

<i>Figure No.</i>	<i>Title</i>	<i>Page</i>
1-1	Test Set Telegraph AN/GGM-16(V)1 .....	1-2
1-2	Test Set, Telegraph AN/GGM-15(V)2 .....	1-3
1-3	Case, Test Set CY 1-4 672/GGM I-16(V).....	1-6
1-4	Dolly, Test Set V 434/GGM-/15(V) .....	1-7
1-5	Cable Assembly, Special Purpose Electrical CX/10105/U.....	1-8
1-6	Cable Assembly, Special Purpose Electrical Branch CC-18024/GM-16(V).....	1-8
2-1	TS-2862/GGM-16(V), typical domestic packaging .....	2-2
2-2	CY 1-4 678/GGM-16(V), typical domestic packaging.....	2-3
2-3	V-484/GGM-16(V), typical domestic packaging .....	2-3
2-4	SG-860/GGM-16 (V), assembly card and fuse locations .....	2-4
2-5	TS-2862/GGM-16(V), assembly card and fuse locations .....	2-4
2-6	OS-206/GGM-(V), assembly card and foes locations .....	2-5
2-7	Power transformer strapping options.....	2-7
2-8	AN/GGM-16(.V), mounting dimensions.....	2-8
2-9	AN/GGM-15(V), cable connections .....	2-9
3-1	SG-860/GGM.16(V), controls and indicators .....	3-2
3-2	TS-2882/GGM-16(V), controls and indicators.....	3-4
3-3	OS-206/GGM-16(V), controls and indicators.....	3-6
3-4	Types of distortion .....	3-7
3-5	Free run message operation (high level neutral).....	3-9
3-6	ASCII code and Baudot alphabet .....	3-10
3-7	Free run selected character operation (high level polar).....	3-12
3-8	External message test setup .....	3-14
4-1	Distortion, oscilloscope display .....	4-4

# CHAPTER 1 INTRODUCTION

---

## Section I. General

### 1-1. Scope

a. This manual describes Test Set AN/GGM15(V). The AN/GGM-15(V) is supplied in two configurations. The AN/GGM-15(V)1 configuration (fig. 1-1) is intended for use in standard 19-inch relay racks and does not include Case, Test Set CY-6672/GGM-15(V) or Dolly, Test Equipment V-434/GGM-15(V). The AN/GGM-15(V)2 (fig. 1-2) includes both the test set case and the test set dolly, and is used as a portable test set. Both configurations contain three major operating units: Generator, Signal SG-860/GGM-15(V), Analyzer, Signal Distortion TS-2862/GGM-15(V), and Oscilloscope OS-206/GM-15(V).

b. Appendix A includes a complete list of the publications referenced in this manual; appendix B provides a maintenance allocation chart; and appendix C provides the organizational repair parts and special tool lists. Appendixes B and C are current as of *October 1970*.

### 1-2. Indexes of Publications

a. *DA Pam 310-4*. Refer to DA Pam 310-4 to determine whether there are any new editions, changes, or additional publications pertaining to the AN/GGM-15(V).

b. *DA Pam 310-7*. Refer to DA Pam 310-7 to determine whether there are any modification work orders (MWO's) pertaining to the equipment.

### 1-3. Forms and Records

a. *Reports of Maintenance and Unsatisfactory Equipment*. Maintenance forms, records, and reports which are to be used by maintenance personnel at all maintenance levels are listed in and prescribed by TM 38-750.

b. *Report of Packaging and Handling Deficiencies*. Fill out and forward DD Form 6 (Packaging Improvement Report) as prescribed in AR 70058/NAVSUPINST 4030.29/AFR 71-13/MCO P4030.29A, and DSAR 4145.8.

c. *Discrepancy in Shipment Report (DISREP) (SF 361)*. Fill out and forward Discrepancy in Shipment Report (DISREP) (SF 36V as prescribed in AR 55-38/NAVSUPINST 4610.33A/AFR 75-18/ MCO P4610.19B and DSAR 4500.15.

d. *Reporting of Errors*. The reporting of errors, omissions, and recommendations for improving this publication by the individual is encouraged. Reports should be submitted on DA Form 2028 (Recommended Changes to Publications and Blank Forms and forwarded direct to Commander, US Army Electronics Command, ATTN: DRSEL-MA-Q, Fort Monmouth, N.J. 07703.

e. *Reporting Equipment Improvement Recommendations (EIR)*. EIR's will be prepared using DA Form 2407, Maintenance Request. Instructions for preparing EIR's are provided in TM 38750, the Army Maintenance Management System. EIR's should be mailed direct to Commander, US Army Electronics Command, ATTN: DRSELMA-Q, Fort Monmouth, New Jersey 07703. A reply will be furnished direct to you.

f. *Administrative Storage*. For procedures, forms and records, and inspections required during administrative storage of this equipment, refer to TM 740-90-L

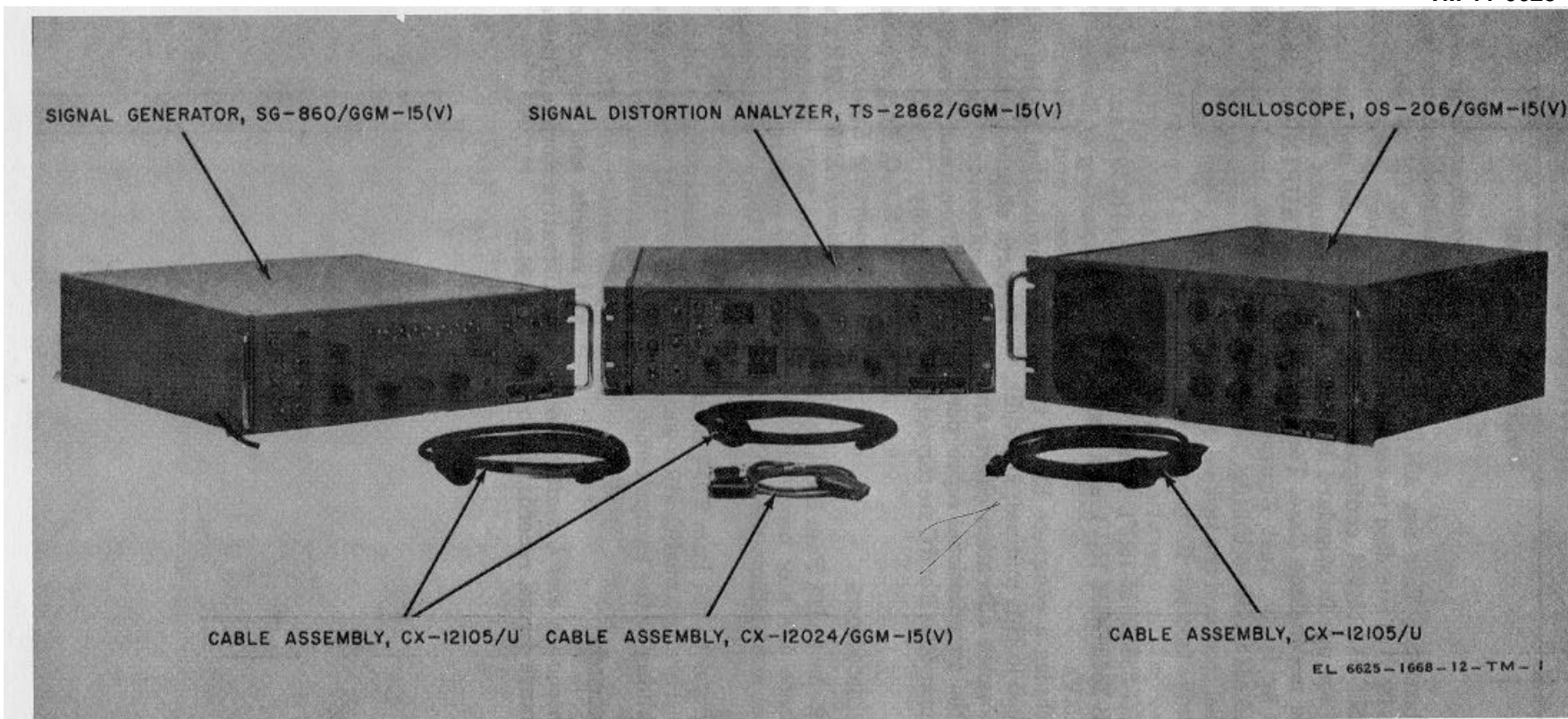
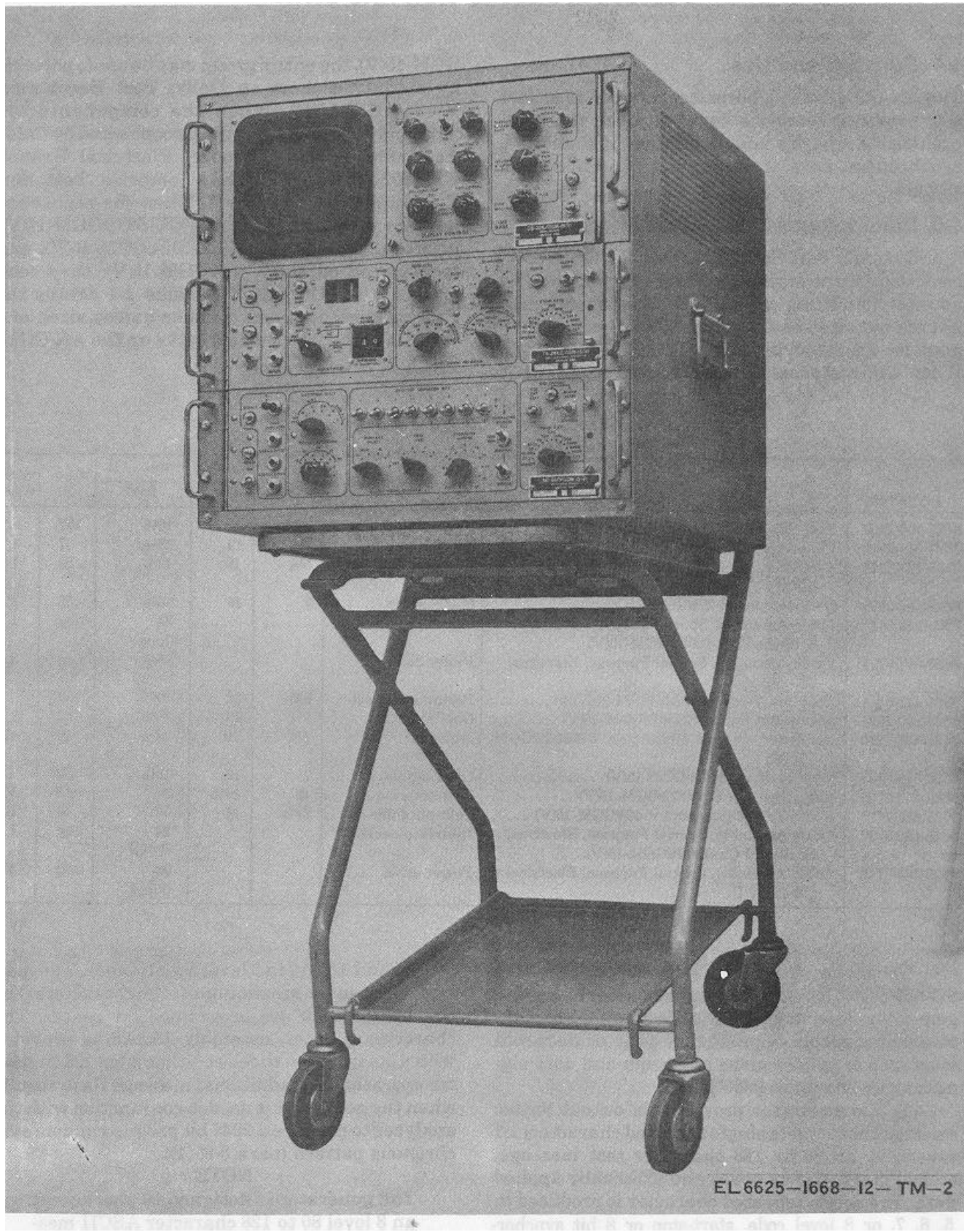

Figure 1-1. Test Set, Telegraph AN/GGM-15(V)1.



EL 6625-1668-12- TM-2

Figure 1-2. Test Set, Telegraph AN/GGM-15(V)2.

Section II. DESCRIPTION AND DATA

1-4. Purpose and Use

The AN/GGM-15G(V), hereafter referred to as test set, provides complete capability for the comprehensive analysis and generation of simulated, synchronous, data, start-stop data and telegraph signals.

1-5. Description of Major Components

a. *General.* Test Set, Telegraph AN/GGM-15(V) consists of three major operating components and an interconnecting cable. These components may be rack-mounted in a standard 19-inch rack or they may be mounted in Case, CY-6672/GGM-15(V). When the components are mounted in CY-6672/GGM-15(V), the entire group may be made portable by mounting them on Dolly, Test Equipment V-434/GGM-15(V). When the components are mounted in a rack and are interconnected by Cable Assembly, Special Purpose, Electrical Branch CX-12024/GGM-15(V), they comprise Test Set, Telegraph AN/GGM-15(V)L When the same components are mounted in the CY-6672/GGM-15(V), interconnected by the CX-12024/GGM-15(V), and transported on the V-4341GGM-15(V), they comprise the AN/GGM-15(V)2. Table 1-1 details the Federal stock numbers, common names, sizes, and weights of the items which make up the AN/GGM15(V).

Table 1-1. Components

Federal stock number	Nomenclature	Common name	Dimensions (inches)			Weight (lbs)	Quantity supplied
			Height	Width	Depth		
6625-464-1702	Test Set, Telegraph AN/GGM-16(V)1 .....	Test Set Set.....	17 1/2	19	18 1/2	107	
6625-219-2525	Generator, Signal SG-860/GGM-16(V) .....	Generator .....	5 1/4	19	18 1/2	37	1
6625435-7776	Analyzer, Signal Distortion, TS-2862/GGM 15(V) .....	Analyzer.....	5 1/4	19	18 1/2	29	1
6625-442-6135	Oscilloscope OS-206/GGM-15(V) .....	Oscilloscope.....	7	19	18 1/2	39	1
6625-443-5527	Cable Assembly, Special Purpose, Electrical Branched CX-12024/GGM-15(V). .....	Interface cable.....	.....	.....	24 (long)	neg	1
6625-497-9791	Cable Assembly, Special Purpose, Electrical CX- 12105/U.....	Power cable.....			96 (long)	neg	3
6625-442-6131	Test Set, Telegraph AN/GGM-15(V)2 .....	Portable test set.....	53 3/8	32	19 5/8	159	
6625-219-2525	Generator Signal SG-860/GGM-15(V) .....	Generator .....	5 1/4	19	18 1/2	37	1
6625-435-7776	Analyzer Signal Distortion TS-28621GGM 15(V).....	Analyzer.....	5 1/4	19	18 1/2	29	1
6625-442-6135	Oscilloscope OS-206/GGM 15(V) .....	Oscilloscope .....	7	19	18 1/2	39	1
6625-442-6132	Case, Test Set CY-6672/GGM-15(V) .....	Test set case.....	19	19 5/8	24	12	1
6625-435-7775	Dolly, Test Equipment V-4341GGM-15(V) .....	Test set dolly .....	34 3/8	18	32	40	1
6625-443-5527	Cable Assembly, Special Purpose, Electrical Branched CX-120241GGM- 15(V). .....	Interface cable.....			24 (long)		
6625-435-7776	Cable Assembly, Special Purpose, Electrical CX-12105/U.....	Power cable.....			96 (long)	neg	3

b. *Generator, Signal SG-8601GGM-15(V).* The SG-860/GGM-15(V), hereafter referred to as the generator, is a completely self-contained test instrument capable of producing clear or distorted start-stop or synchronous telegraph and data signals at speeds up to 9600 bauds.

(1) The generator provides six output forms: selected character (a single repeated character) 1:1 reversals, an 80 or 128 character test message, steady mark, steady space and externally applied data. The single repeated character is produced in 5, 6, 7, or 8 level code, start stop or 8 bit synchronous. The test message is programmed in assemblies 1A2A5 and 1A2A7 in 5 level Baudot code. The message contains a maximum of 128 characters, the last 48 of which are programmed for spaces. The character counter, assembly 1A2A8, is provided with a strap option to select either 80 or 128 character operation. An additional message form results when the generator is used in conjunction with the analyzer to produce a 2047 bit pseudo-random synchronous pattern (pare 3-8b(V)).

NOTE

The generator is designed to also accept an 8 level 80 to 128 character ASCII message format. This feature requires the addition of an 80 character 8 level matrix (assembly 1A2A6) and the substitution of the 48 character 5 level matrix (assembly 1A2A5 with a new 48 character 6 and 8 level matrix assembly.



(2) Bias and end distortion are generated digitally within the generator and is added to the output signal in 1% increments up to a maximum of 49% Stop length is controlled by the combined setting of the CODE LEVEL and CHARACTER LENGTH switches. The CHARACTER LENGTH switches extend the length of a character from 7 to 16 bits (para 3-7b(4)). Character release is controlled manually by the operator, automatically by the generator or externally by an external step pulse.

(3) A crystal controlled time base is provided for operation at 12 speeds in the 37.5 to 9600 baud range. A spare speed position is also included and requires only the addition of a crystal and the appropriate timing division strap to operate in the above speed range (para 3-7e(1)). An external oscillator position is provided for use with an external timing source, the frequency of which, in hertz, is 200 times the desired operating baud rate. The amplitude of the external timing signal must be  $\pm 6$  volts  $\pm 1$  volt into an input impedance of 6000 ohms. The generator may be synchronized to a station master clock which produces a clock signal equal to 2 times the desired baud rate. When the generator is used in this mode, the distortion circuits are inoperative.

(4) The high level output provides polar keying of up to  $\pm 150$  volts; neutral keying of up to 300 volts at 100 ma. maximum. High level loop power must be supplied from an external power supply. At speeds above 150 baud the high level output circuit assumes a steady mark condition. The low level output provides a MIL STD-188B  $\pm 6$ -volt polar  $\pm 1$ -volt data output signal of 0 to 10 ma. The low level output circuits use the internal power supply. Both high and low level outputs are isolated from logic ground. The generator may be internally strapped to provide either a positive or negative marking sense (Factory strapped for positive mark). A MIL-STD-188B  $\pm 6$ -volt clock output is available from the front panel at the rate of one cycle per bit. The polarity of the clock signal is such that the positive going transition occurs in the center of each data bit.

*c. Analyzer, Signal Distortion TS-2862/ GGM-15(V).* The TS-2862/GGM-15(V), which will hereafter be referred to as the analyzer, is a completely self-contained solid-state test instrument

(1) This instrument performs three major functions; distortion analysis, distortion monitoring, and error rate determination with the ability to define errors. The types of distortion measured are marking or spacing bias, marking or spacing end, total peak, early and late peak, cyclic characteristic and fortuitous distortion. The instrument is capable of measuring distortion on all transitions of a character or on individually selected transitions within a character.

(2) Transition selection is made from a front panel control. The ability to measure distortion on individually selected transitions of a start-stop signal permits measurement of cyclic distortion and speed error distortion. When measuring synchronous signals, the analyzer synchronizes to M/S transitions and measures the displacement of all S/M transitions. In the peak monitor mode of operation the nixie readout displays the number of times the distortion measured exceeds the threshold setting of the ERROR DEFINER thumbwheel switches. The distortion threshold (ERROR DEFINER thumbwheel switches) select from 0 to 49 % in 1 % increments. In the error rate mode of operation, a 2047 bit pseudo-random test pattern from another analyzer is compared with an internally operated pseudo-random pattern. The analyzer automatically synchronizes to the received pattern on a bit and frame basis and counts the number of errors (as defined by the error definer thumbwheel switches) in each one thousand or one million bit times; The result is displayed in a digital readout which provides an overflow indication when the error rate exceeds 99 bits per thousand, or 99 bits per million. The error definer allows for bit errors to be narrowly defined by comparing the logic state of the input error signal with the state of an internally generated perfect pseudo-random test message. If the input signal is distorted or if a bit is not in coincidence with the internal perfect pattern an error is detected. A built-in error test mode is provided which is implemented when the analyzer is used with its companion Signal Generator SG 860/ GGM-16(V) in order to self-check the error rate and error defining functions of the analyzer.

(3) A crystal controlled time base is provided for operation at 12 speeds within the 37.6 to 9600 baud range. A spare speed position is also furnished and requires only the addition of a crystal and the proper strapping to operate the unit at the desired speed range. An external oscillator position is provided for use with an external timing

source. The frequency of this external timing source must be 200 times the desired baud rate. The amplitude of external timing signal must be  $\pm 6$  volts  $\pm 1$  volt into an input impedance of \*6000 ohms (\*conforms with MIL-STD-188B). The analyzer will process input signals that are neutral negative or positive on current loops of 20 to 70 milliamperes. It will also accept high level polar signals on current circuits of 20 to 30 ma and low level polar signals of  $\pm 6$  volts at 1 ma to conform with MIL-STD-188B. Proper sensing is accomplished by means of the mark polarity switch. The unit operates on 156/230 volts ac single phase 47-63 hz. The self-contained dc power supply provides  $\pm 5$  volts dc for the analyzer logic levels. The  $\pm 15$  volts dc is used to operate the input amplifiers, oscillators, error code generator, and indicator lamps. The +200 volts dc is used to drive the nixie tubes.

d. *Oscilloscope OS-206/GGM-15(V)*. The OS-206/GGM-16 (V), hereafter referred to as the oscilloscope, is a versatile instrument used in conjunction with its companion unit the signal distortion analyzer. This unit is designed to display on a 6-inch cathode ray tube, the characters or selected bits of a character being analyzed by the analyzer. Since the oscilloscope functions in much the same manner as conventional oscilloscopes the operator should have little difficulty in understanding the operation of the OS-206/GGM-15(V). The function of the controls on this unit are comparable to the function of corresponding controls on other oscilloscopes.

(1) The FOCUS and ASTIG controls operate in conjunction with each other to obtain a sharp and clearly defined trace.

(2) The INTENSITY CRT control is used to adjust the brightness of the oscilloscope display. The graticule is illuminated and is adjusted by means of the SCALE illumination control located with the INTENSITY CRT control. The graticule is marked with 10 major vertical divisions, each major division is subdivided into 1-4 units. The horizontal graticule consists of an upper scale of seven divisions and a lower scale of ten divisions. The seven division scale is used to measure the width of a bit in a five level code character (Start-Stop and five bits) while the lower scale is

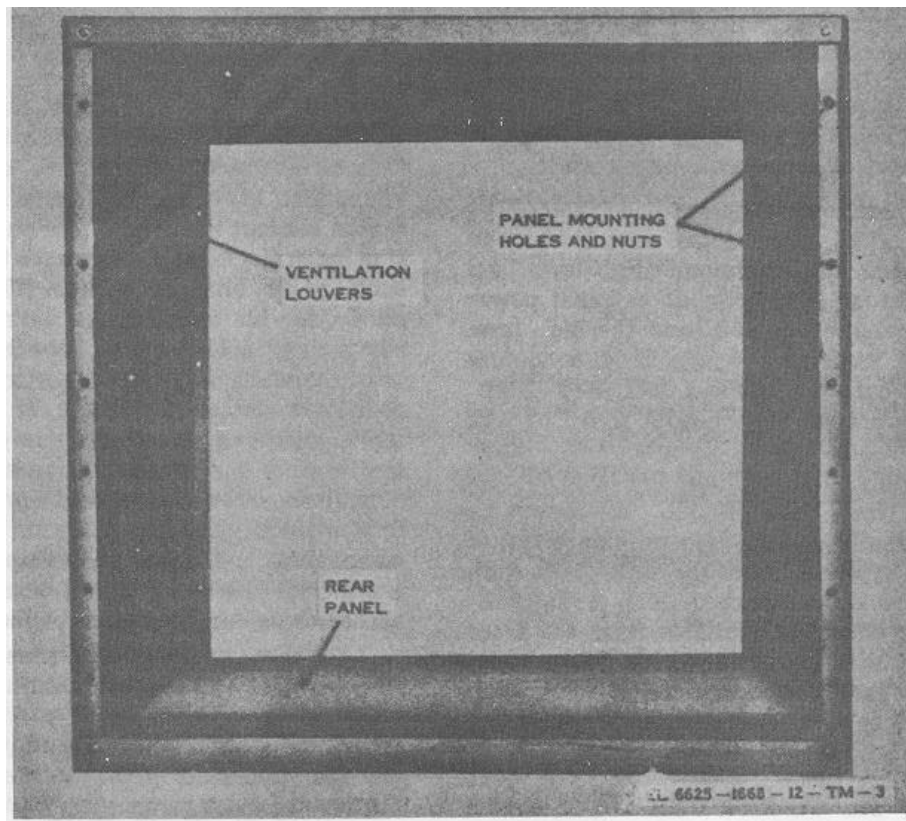

Figure 1-3. Case, Test Set CY 1-4 672/GGM-15(V).

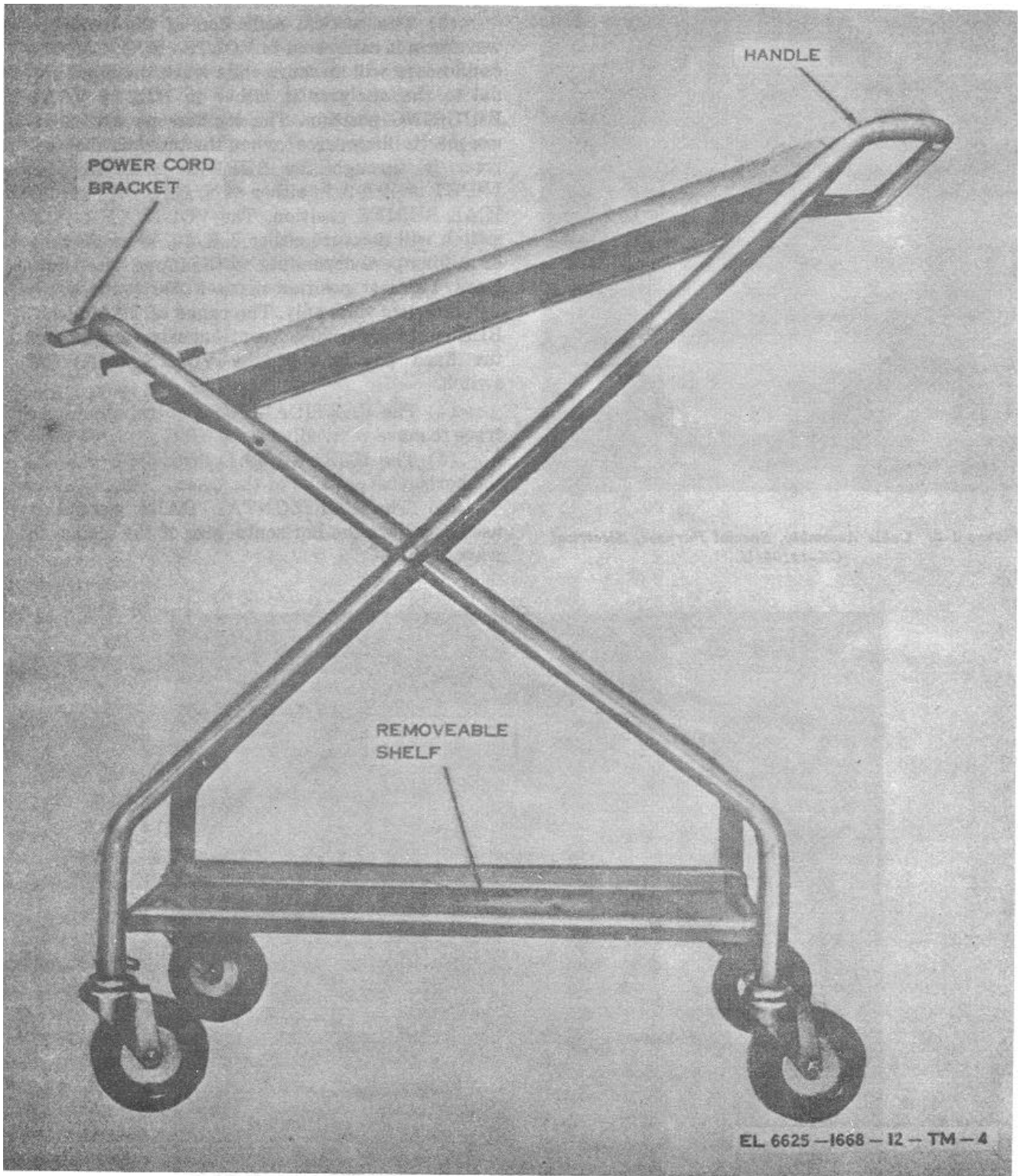
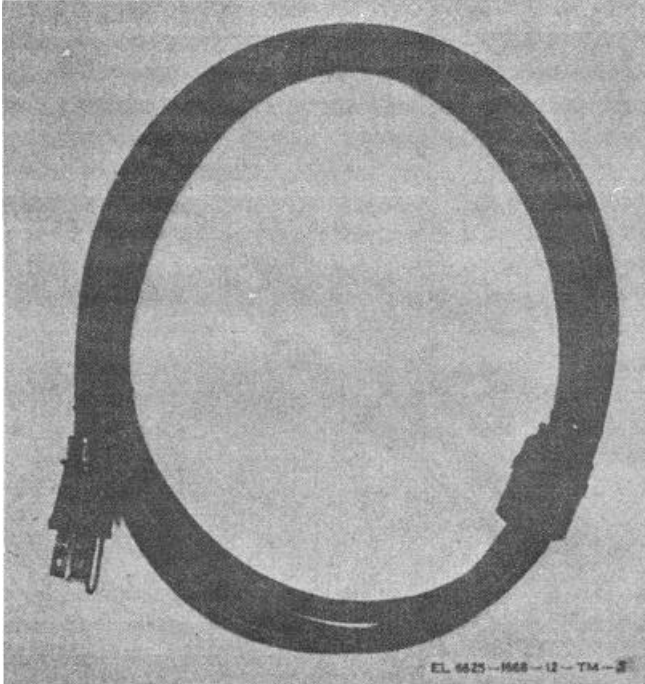

Figure 1-4. Dolly, Testt Set V-434/GGM-15(V).



used for an eight level code character (Start-Stop and eight bits).

(3) The vertical deflection of the displayed waveform is calibrated in VOLTS (MA)/CM. The oscilloscope will measure volts when the input signal to the analyzer is either in HIZ or VCAL BRIDGING position. The oscilloscope will measure ma (milliamperes) when the input to the analyzer is through the SERIES jack, and the INPUT switch is in either 60N, 20N, 20P, 30P or ICAL SERIES position. The VOLTS (MA)/CM switch will measure either 2, 5, 10, 20 or 60 volts or milliampere depending on the input to the analyzer. The last position marked 200 (volts only) will measure volts only. The range of the VARIABLE control is  $\pm 20\%$  (continuously variable) of the fixed positions of the VOLTS (MA)/CM switch.

(4) The VERTICAL POS Control allows the trace to move vertically on the CRT.

(5) The HORIZONTAL POSITION adjusts the horizontal position of the trace.

(6) The HORIZONTAL GAIN control is used to adjust the horizontal size of the displayed waveform.

Figure 1-5. Cable Assembly, Special Purpose, Electrical CX-15106/U.

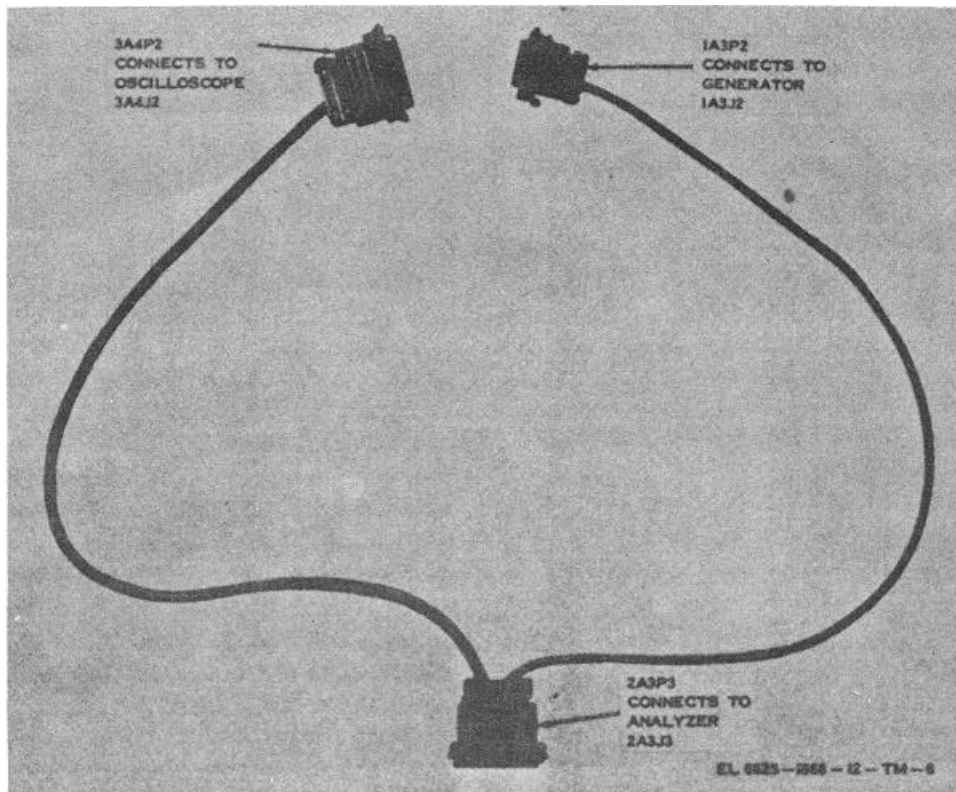

Figure 1-6. Cable Assembly, Special Purpose Electrical, Branched CX-12024/GGM-15(V).

(7) The Z MARKER facilitates making accurate measurements of the mark/space transitions of a bit. By means of this switch it is possible to intensify the brightness of the leading and falling edges of the bit so that measurements are made directly from the calibrated graticule. This is accomplished when the Z MARKER switch is in the ON position. When a polar signal is displayed on the screen the positive bit is above the zero axis and the negative bit is below the zero axis.

The brightness of all positive and negative transitions of the character will be intensified. On neutral, negative or positive signals the baseline of the signal is the zero axis, and the intensification will take place above the midpoint of the leading edge and from the midpoint to the baseline on the falling edge.

(8) The oscilloscope sweep circuit can be operated in an automatic mode, an internally triggered mode or a free running mode.

(a) In the automatic mode the sweep is generated internally and is triggered by the analyzer speed and code level settings.

(b) In the internally triggered mode the sweep is generated within the oscilloscope and triggered by a signal from the analyzer, which produces one sweep for each character.

(c) In the free running mode the sweep is triggered through the use of periodically recurrent waveforms generated within the oscilloscope. This mode provides a convenient means for viewing crossover patterns.

(d) In the internal mode the sweep release rate is controlled by the operator. In this mode, the DISPLAY RELEASE RATE switch is set to tile VARIABLE position, causing the sweep to release once per character. The repetition rate of the displayed character can be varied from 1 to 2 seconds by rotating the DISPLAY RELEASE RATE control clockwise.

(e) In the free running and internal modes of operation the horizontal sweep is controlled by the TIME MTLISEC switch. This switch provides horizontal sweep from 50 microseconds to 500 milliseconds in five steps. Each of these steps is adjustable by means of an overlapping vernier control.

(f) When a particular transition within a character, the sweep trigger Signal is applied one-half bit preceding the transition to be measured. This function is controlled by the TRANSITION switch on the analyzer. When a transition is selected, a blanking pulse will allow only the desired transition to be visible on the screen.

e. *Dolly, Test Set V 434/GGM-15(V). The V 434/GGM-16(V)*, hereafter referred to as the dolly (fig. 1-4), is equipped with four swivel wheels or casters and is used to transport and position the test set at a convenient level. The dolly is provided with a removable lower shelf for the storage of unused test equipment. A power cable bracket is provided to store the power cables when not in use. For storage, the dolly is folded into a flat package.

f. *Cable Assembly, Special Purpose, Electrical CX-12105/U*. The CX-12105/U, hereafter referred to as power cable (fig. 1-6) is a three-wire cable, approximately 8 feet in length. One-cable connects each major component to the ac power source.

g. *Cable Assembly, Special Purpose, Electrical Branch*. The CX-12024/GGM-16(V), hereafter referred to as interface cable (fig. 1-6) is a special purpose cable used to interconnect the generator, analyzer, and oscilloscope. The cable is approximately 2 feet long and has three connectors. Each connector is of a different size and will only connect to the appropriate unit.

## 1-6. Technical Characteristics

The technical and physical characteristics for each major component of the test are listed below.

### a. Generator Characteristics

Output message forms ..... Steady "MARK"  
Steady "SPACE"  
1:1 Reversals

Selected Character- 5, 6, 7 or 8-level start-stop or 8-bit synchronous.

Message--5-level 80 characters, may be strapped for an additional 48 field programmable characters which are normally spaces. The standard 80 character message is: CR CR LF LET TEST SP DE SP B/L B/L B/L B/L B/L B/L SP SP SP SP LET THE SP QUICK SP BROWN SP FOX SP JUMPS SP OVER SP THE SP LAZY SP DOG FIG. SP 1234567890

Where-  
 CR = Carriage Return  
 LF = Line Feed  
 LET = Letters shift  
 SP = Space (horizontal shift)  
 B/L = Blank (nonspace)  
 FIG = Figures Shift

*External*--The generator accepts a 2047 bit pseudo-random undistorted test pattern from the Analyzer; by way of a rear panel connector, adding controlled amounts of marking or spacing bias distortion to the signal and retransmits the signal at any of its outputs.

This feature may be used in checking the Error Rate/Error Definer operation of the Analyzer. It may also be used as an additional message form in testing synchronous data systems and equipment.

Character release modes.....	<i>Free-run</i> --Synchronous or start-stop with selectable character length of 7.0 to 16.0 units. <i>Stepped</i> --start-stop only. Manual character release by front panel pushbutton. Electrical character release external source-60 volts dc at 2 ma. (operational 6 volts or contact enclosure input available).
External timing synchronization ...	The generator may be synchronized with a station master clock (MIL-STD-188B low level input) using signals at bit rate of 2 X the desired output rate in bauds to produce undistorted test signals at the data outputs. The generator may be operated from an external oscillator at a frequency in Hertz of 200 times the desired operating speed in bauds to produce clear or distorted outputs. Requires polar signal $\pm 6$ volts $\pm 20\%$ . Input impedance of 6000 ohms.
Internal timing.....	Crystal controlled timing source for operation at speeds of 37.6, 46.6, 60, 61.1, 75, 160, 800, 600, 1200, 2400, 4800, and 9600 bauds with built in provision for one spare speed which can be activated by adding a crystal and a wire link to produce any speed in the range of 30 to 9600 bauds. Stability .01 % per day.
Distortion.....	Accuracy $\pm 1\%$ distortion under all conditions. Types--" <i>No Distortion</i> ": Overrides distortion switch settings. <i>Bias</i> : Marking, Spacing, Switched. <i>End</i> : Marking, Spacing. Amount--0% to 49% in 1% steps.
Electrical output.....	<i>High Level</i> --Polar/neutral isolated keyer for 800 volt neutral, 150V polar, 100 ma. maximum. Loop-power supplied externally. Output fused for 260 ma. Maximum operating speed of 160 bands. <i>Low Level</i> --MIL-STD-188B Low Level output keyer uses either $\pm 6$ V or +12V isolated internal supplies (strapping option can produce negative mark). <i>Clock</i> --Data timing output at bit rate of 2X data rate at MIL-STD-188B low level.
Indicators:	
Signal .....	Signal indicator lights for "MARK" output.
Clock .....	Alarm light indicates loss of timing.
Input power.....	115/230 vac $\pm 10\%$ , 47 420 Hz 30 watts.
Physical.....	51/4 high, 19" wide, 18 1/2 behind front panel. Handles and removable flanges for portable applications. Weight: 31 pounds (approximately).

*b. Analyzer Characteristics*

Measurements.....	<i>Distortion Mode</i> --All types telegraph distortion (Transaction Displacement) including-Marking and spacing bias Marking and spacing end Total Peak Early Peak Late Peak <i>Peak Monitor Mode</i> --Monitors live traffic and registers a count on the readout each time the distortion measured exceeds the threshold set on the thumbwheels. Percent threshold is adjustable from 0 to 49% in 1% steps.
-------------------	---

.....	<p><i>Error Rate Mode</i>--The instrument uses a 2047 bit pseudo-random test pattern from another analyzer and compares it with an internally generated "perfect" pattern. The unit automatically synchronizes with the receive pattern on a bit and frame basis and measures the number of errors (as defined by the error definer) in each one-thousand or one-million bit times. The result is displayed on the digital readout with an overflow indicator, indicating when the error rate exceeds 99. The error definer feature allows for a bit error to be narrowly defined by comparing the logic state of the input error signal with the state of an internally generated perfect pseudo-random test message. Errors may also be defined as those transitions whose distortion exceeds a preset % distortion threshold. The threshold may be set at 1% intervals from 0 to 49%. An error test mode is built into the unit. A companion unit (the generator) is used to self-check the error rate and error defining functions of the analyzer.</p>
Accuracy .....	Plus or minus 1% (Distortion) or $\pm$ one count (Error rate or Hits).
Measurement indicator .....	A 2 digit nixie display is used for % Distortion, hits count, or error rate depending on selected operating mode.
Lamp indicator.....	<p><i>Signal</i> indicator lamp lights for "marking" input signal.  <i>Overflow</i> indicator lamp lights when error rate or hit count exceeds 99.</p> <p><i>Clock</i> indicator lamp lights when timing signal is missing.</p>
Display reset.....	<p>Mark and space lamps indicate type of distortion mode. They also indicate start and end of test in the error rate mode.</p> <p>Automatic (3 to 6 seconds) or manual reset of nixie display for peak distortion measurement. Manual reset used to start new test in ERROR Rate mode and peak monitor mode.</p>
Internal timing.....	Crystal controlled timing source for operation at speeds of 37.5, 45.5, 50, 61.1, 75, 150, 300, 600, 1200, 2400, 4800, and 9600 bands with built-in provision for one spare speed which can be activated by adding a crystal and jumper wire to produce any speed in range of 30 to 9600 bands. Stability .01% per day.
External timing.....	The analyzer may be operated from an external oscillator at a frequency in hertz of 200 times the desired operating speed in bands. Requires polar signal +6 volts, $\pm$ 20% Input impedance of 6000 ohms.
Inputs .....	Series, current (limited to a maximum speed of 160 bands). 20 ma neutral 200 ohms nominal 60 ma neutral 67 ohms nominal 20/30 ma polar 200 ohms nominal Front panel switch for selection of input polarity. (Fused for 100 ma on input assembly)
Input character interval .....	<p>Bridging (voltage)-Polar MIL-STD 188B <math>\pm</math>0.5 volts to <math>\pm</math>150 volts (68K ohms).</p> <p><i>Start-Stop</i>-- 5, 6, 7, 8 level with any stop length.</p> <p><i>Synchronous</i>-All codes. Automatic synchronizer provides phase-locking between analyzer timing and input signals with timing differential not greater than 0.1%.</p>
Input signal filtering .....	Front panel control allows for filtering transients less than 1/2 millisecond on speeds up to 150 bands.
Transition selection.....	In the distortion mode measures "ALL" or individual transitions Ott start-stop input signals.
Input power.....	115/230 VAC $\pm$ 10%, 47-420 Hz, 45 watts.
Physical.....	5 1/2 high, 19" wide, 18 1/2 behind front panel. Handles and removable flanges for portable applications. Weight: approximately 29 pounds.

*c. Oscilloscope Characteristics.*

Display .....	Displays input signal from the analyzer on a 6-inch CRT (P-7 phosphor) using electrostatic deflection and intensity modulation. DC to 450 Hz.
Vertical	<p>Calibrated graticule provides measurement of signals applied to the Analyzer.</p> <p>SCALES-</p> <p>Current: 2, 6, 10, 20, 60 ma/cm.</p> <p>Voltage: 2, 6, 10, 20, 60, 200 volts/cm.</p>

Horizontal .....	Scale calibrations are provided for both 5-level and 8-level codes.
TRIGGER AND SWEEP MODES:	<p><i>Auto--Triggering</i> is external from the analyzer. The sweep is a digital ramp wave-shape derived by decoding character timing signals from the analyzer unit. Sweep rate adjusts automatically to display one start-stop character or 8 synchronous bite.</p> <p><i>Internal Triggering</i> is external from the analyzer. The sweep is a linear ramp waveshape derived internally with a rate determined by the variable time base control.</p> <p><i>Free-Run--Triggering</i> is internal. The sweep is a linear ramp waveshape derived internally with a rate determined by the variable time base control</p>
Variable time-base..... (0.05, 0.5 ,5, 50 and 500 ma) with an overlapping denier control.	Provides sweep times from 60 micro-seconds to 600 milliseconds in five ranges
Z-axis intensification .....	Transition intensification is provided with a front panel on-off switch. Intensifies first 10% of a bit at all speeds.
Display release modes.....	<p><i>Normal--</i>Blanking signals from the analyzer provides for display of each character, Blanking signals from the analyzer provide a continual display of the complete horizontal sweep for all modes of trigger ant sweep Select when the analyzer transition control is in the "ALL" position.</p> <p>When the analyzer transition control is in position "1" through "9" (start-stop signals only) the selected transition time period (60% earlier to 60 % later than ideal transition point) is displayed with the balance of the sweep blanked out. This type of blanking operates in both the AUTO and INT. positions of the trigger and sweep select. In the AUTO position, the sweep starts at the beginning of a character. In the INT. position the sweep starts at the beginning of the selected transition time period.</p> <p><i>Variable--</i>Blanking signals produced internally provide a controlled display release rate variable from 1 to 2 seconds between sweeps.</p> <p><i>Manual--</i>A single sweep is displayed through operation of a front panel, spring-switch.</p>
Input power.....	115/280 VAC $\pm$ 10%, 47-420 Hz, 30 watts.
Physical.....	7" high, 19" wide, 18 behind front panel, handles and removable flanges for portable applications, Weight: Approximately 89 pounds.



**CHAPTER 2  
INSTALLATION**

**2-1. General**

a. This chapter contains the procedures and diagrams required for unpacking, inspection, and installation of Telegraph Test Set AN/GGM-15 (V).

b. Installation instructions include external equipment connections and strapping options for front and rear panel access to the data signals. Additional strapping options, and operation with external equipment are discussed in chapter 3.

**2-2. Unpacking**

a. *Packaging Data.* The components of the test set are packed in individual cartons for domestic shipment. For overseas shipment, these cartons may be sealed in moisture-vaporproof wraps and inclosed wooden crates. Figures 2-1, 2-2 and 2-3 show the units packaged in the domestic cartons. Figure 2-1 shows the packaging of the analyzer. This carton also contains the interface cable, power cable, running spares, and technical manual. The generator and oscilloscope are packed in the same manner as the analyzer excluding the interface cable, running spares, and technical manual. The domestic packaging of the test set case and dolly are shown in figures 2-2 and 2-3. The carton numbers, dimensions, weights, and contents are listed as follows:

Box No.	Dimensions (in)	Volume (cu ft)	Unit Weight (lb)	Contents of box
1	10.6 x 20.5 x 22	2.7	45.5	OS-206/GGM-15 (V) and CX-12105/U.
2	10.5 x 20.5 x 22	2.7	41.5	TS-2862/GGM-15 (V), CX-12105/U, CX-12024/GGM-15 (V) and TM-11-6625-1668-12.
3	10.5 x 20.6 x 22	2.7	40	SG-860/GGM-15 (V) and CX-12106/U.
4	20 x 20 x 28	6.4	28.5	CY-6672/GGM-15 (V).
5	11 x 21 x 44.5	5.9	48	V-484/GGM-15 (V).

b. *Removing Contents.* When unpacking the equipment from wooden crates, perform all of the procedures outlined below. When unpacking equipment from domestic cartons, perform only the procedures given in (4).and (5) below:

(1) Cut and fold back the steel straps.

(2) Remove the nails from the top and one side of the box with a nailpuller. Remove the top and side.

Do not pry top or side off; this may damage the equipment.

(3) Open the moisture-vaporproof liner inside the box and remove the carton.

(4) Open the carton and remove the contents.

(5) Preserve the packing materials and cartons for use in repacking the equipment.

**2-3. Checking Unpacking Equipment**

a. Inspect the equipment for damage incurred during shipment. If the equipment has been damaged report the damage on DD Form 6 (para 1-3b).

b. Check the equipment for completeness as listed on the packing slip. Report all discrepancies on Discrepancy in Shipment Report (DISREP) (SF 861) (para 1-3c).

**NOTE**

Storage of a minor assembly or part that does not affect proper functioning of the equipment should not prevent use of the equipment.

c. If the equipment has been used or reconditioned, check to see if it has been changed by a modification work order (MWO). If the equipment has been modified, the MWO number will appear on the front panel near the nameplate.

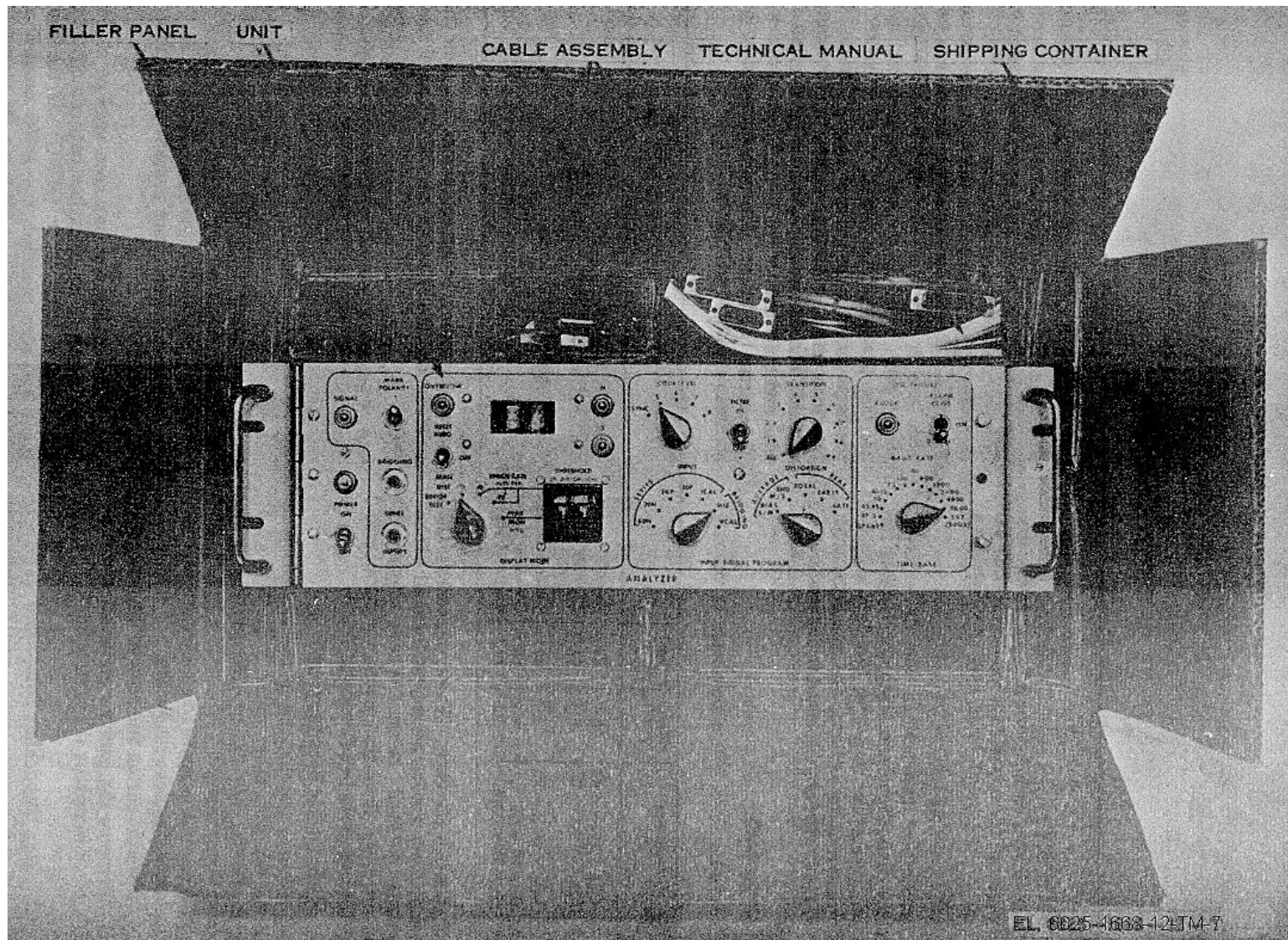

Figure 2-1. TS-2862/GGM-15(V0, typical domestic packaging.

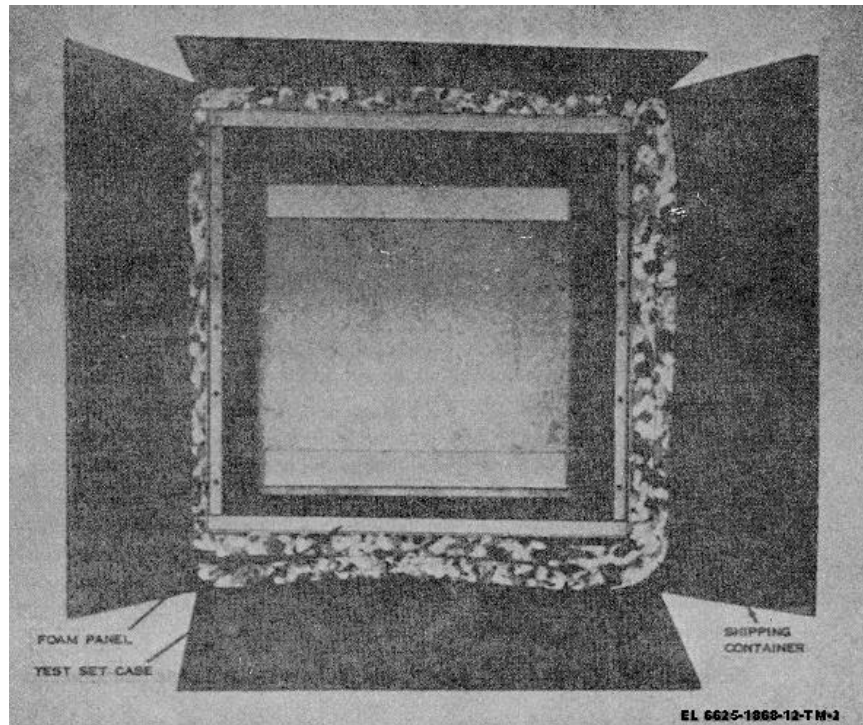

Figure 2-2. CY-6672/GGM-15(V), typical domestic packaging.

Check to see whether the MWO number (if any) and appropriate notations concerning the modification have been entered in the equipment technical manual.

**NOTE**

Current MWO's applicable to the equipment are listed in DA 310-7.

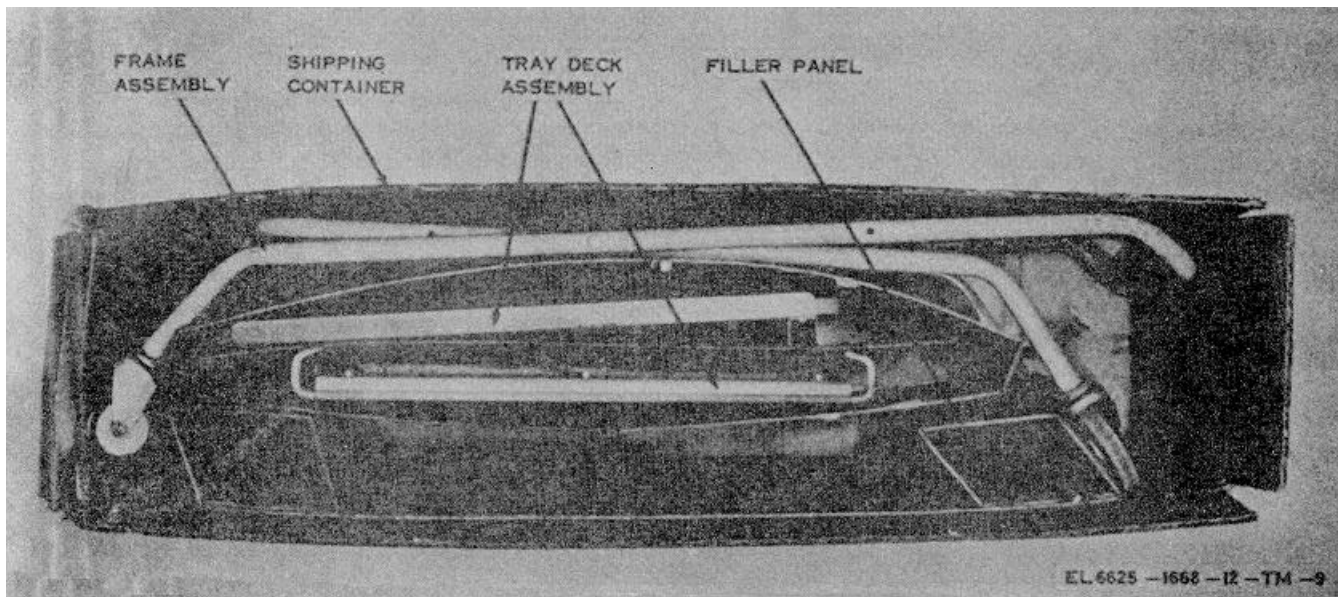

Figure 2-3. V-343/GGM-15(V), typical domestic packaging.

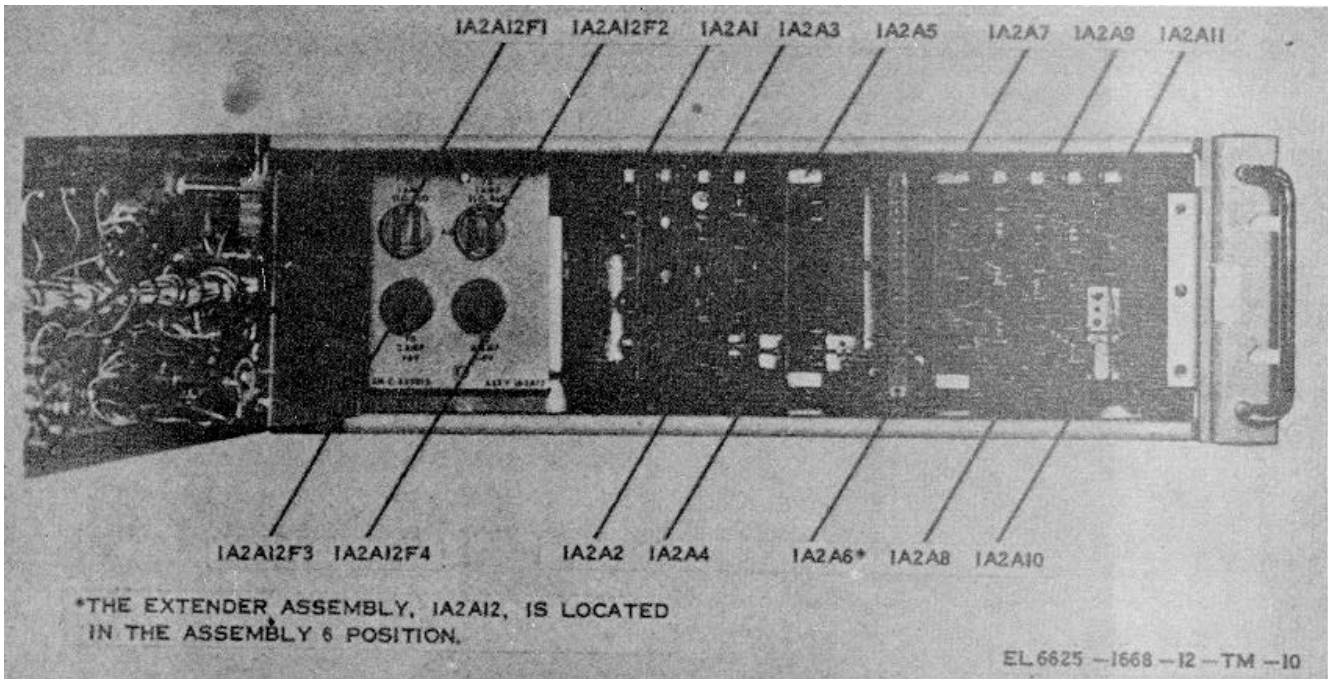

Figure 2-4. SG-860/GGM-15(V) assembly, card and fuse location.

d. Inspect the generator, analyzer, and oscilloscope for the following:

- (1) Inspect for signs of physical damage, dents in the case, damage to rear panel connectors and front panel controls and indicators.

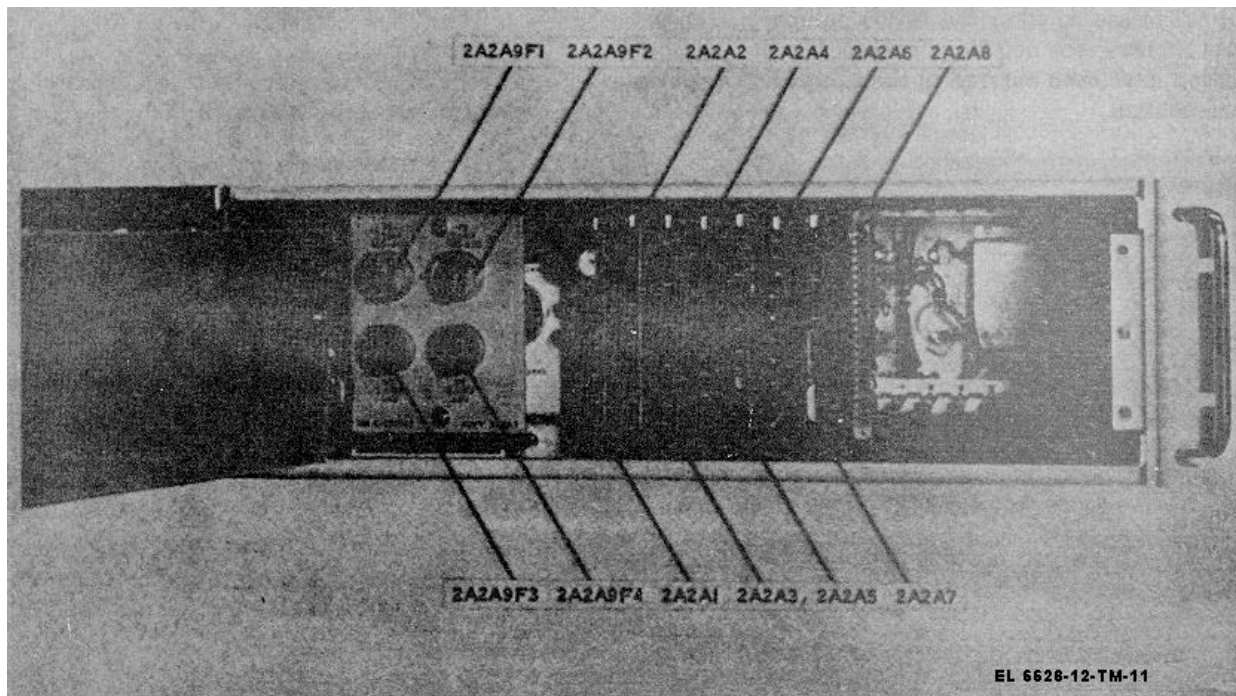

Figure 2-5. TS-2862/GGM-15 (V) assembly, card and fuse load.

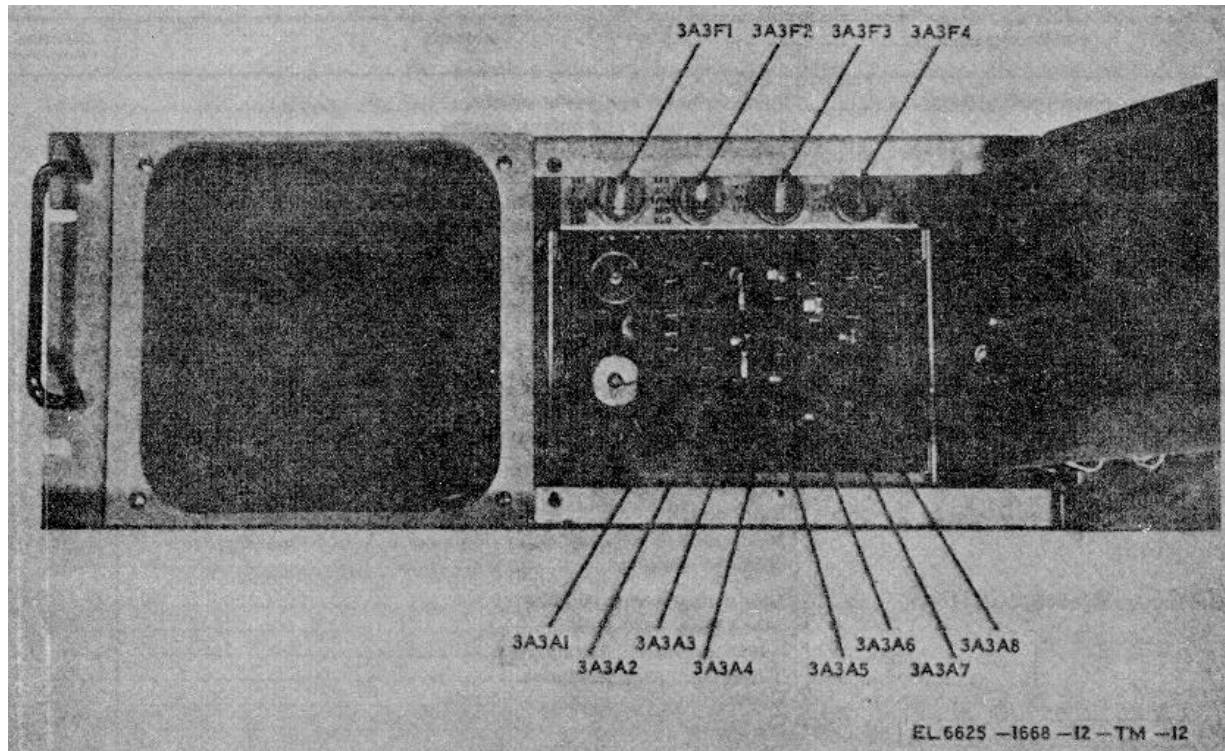

Figure 2-6. OS-206/GGM-15 (V) assembly, card and fuse locations.

- (2) Operate each front panel control to assure freedom of movement.
- (3) Check front panel locking screws and hinges for signs of damage.
- (4) Open and lock front panel, and check the position of each plug-in assembly. Refer to paragraph 2-3 and figures 2-4, 2-5 and 2-6 to check each plug-in assembly for proper location.
- (5) Check each plug-in assembly for secure engagement with the appropriate connector.

#### NOTE

An extractor handle located on the extender assembly is supplied with each major component for removing and replacing plug-in assemblies. Attach the extractor handle to the two holes on the front edge of each assembly and pull straight out to remove. To install plug-in assembly, place the assembly into the appropriate guide rails and firmly push into place to engage the connector.

- e. Inspect the test set case for dents that may interfere with the insertion of the major components.
- f. Inspect the dolly for free wheeling ability and firm support of the test set.

#### 2-4. Reference Designations

a. The plug-in assemblies for each of the major components are identified by reference designations which include the assembly number. The first number of the reference designation, 1, 2, or 3 refers to the major component generator, analyzer, or oscilloscope respectively. The second part of the designation refers to the chassis, A1, A2, or A3. The last part of the designation is the assembly number, A1, A2, A3 etc. The complete reference designation for plug-in assembly 1 of the generator is 1A2A1, the analyzer, 2A2A1, and the oscilloscope, 3A3A1.

b. The plug-in assemblies for each major component and their reference designations are listed in table 2-1. Assembly locations are illustrated in figures 2-4, 2-5, and 2-6.

Table 2-1. Plug-In Assembly Reference Designation

Major Component	Assembly	Reference Designation
Signal Generator SG-860/GGM-15 (V) .....	Bit distributor and power supply .....	1A2A1
	High level input and output circuits.....	1A2A2
	Low level input and output circuits.....	1A2A3
	Distortion circuits .....	1A2A4
	5 level expandable matrix (48 characters) .....	1A2A5
	Extender assembly (optional 8 level matrix).....	1A2A6
	5 level matrix (80 characters) .....	1A2A7
	Character counter .....	1A2A8
	Bit timer .....	1A2A9
	Distortion gate generator .....	1A2A10
Oscillator and time-base.....	1A2A11	
Signal Distortion Analyzer TS-2862/GGM-15(V)	Error counter and oscillator alarm circuits.....	2A2A1
	Error code generator .....	2A2A2
	Transfer control and bit counter .....	2A2A3
	Peak detector .....	2A2A4
	Units tens decades .....	2A2A5
	Input circuits.....	2A2A6
	Oscillator and timebase.....	2A2A7
	Extender assembly .....	2A2A8
Oscilloscope OS-206/GGM-15 (V) .....	Low voltage power supplies.....	3A3A1
	Low voltage regulators.....	3A3A2
	Z markers and D/A converters .....	3A3A3
	Time-Base/sweep generator .....	3A3A4
	Calibration and attenuation circuits .....	3A3A5
	D/A ladder driver .....	3A3A6
	Horizobntal and vertical amplifiers.....	3A3A7
	Extender assembly .....	3A3A8

**2-5. Shelter Requirements**

Shelter requirements for the AN/GGM-15 (V) are the same as for other indoor exchange equipment. Protection must be provided from moisture, dirt, dust, shock, and extreme temperatures.

**2-6. Tools and Test Equipment Required for Installation**

Only common, nonpowered handtools are required for the installation of the test set in either AN/GGM-15 (V) 1 or AN/GGM-15 (V) 2 configurations.

**2-7. Installation**

Installation procedures for the test set depend upon the configuration supplied. When the test set is supplied in the AN/GGM-15(V) 2 configuration, the major components are mounted in the test set case in the same manner as the AN/GGM-15(V) 1, in a standard 19-inch rack. The interface cable connections are the same in either configuration.

*a. Transformer Strapping.* The three major components of the test set may be strapped for either 115 or 230 volt ac operation at 47 to 63 Hz. When shipped from the factory these components are strapped for operation at 115 volts ac  $\pm$ 115 volts. If required to operate at 230 volts ac  $\pm$ 23 volts the following procedure must be performed:

(1) Remove the top cover from each of the major components exposing the power transformers. The transformers are located at the rear of each chassis and the terminals are clearly marked.

(2) Compare the wiring of the transformer with the wiring illustrated in figure 2-7.

(3) Change the transformer wiring to agree with the 230-volt ac hookup.

*b. Rack Installation.* The test set occupies only 17.5 inches of rack space. Mounting hardware is not supplied. Four rack screws are required to mount each major component. The arrangement and dimensions used for rack-mounting are illustrated in figure 2-8. If necessary, drill holes as required for mounting, and perform the following steps:

(1) Position the generator in the rack or cabinet, to be the lowest unit of the group. Secure the unit in the rack or cabinet with screws.

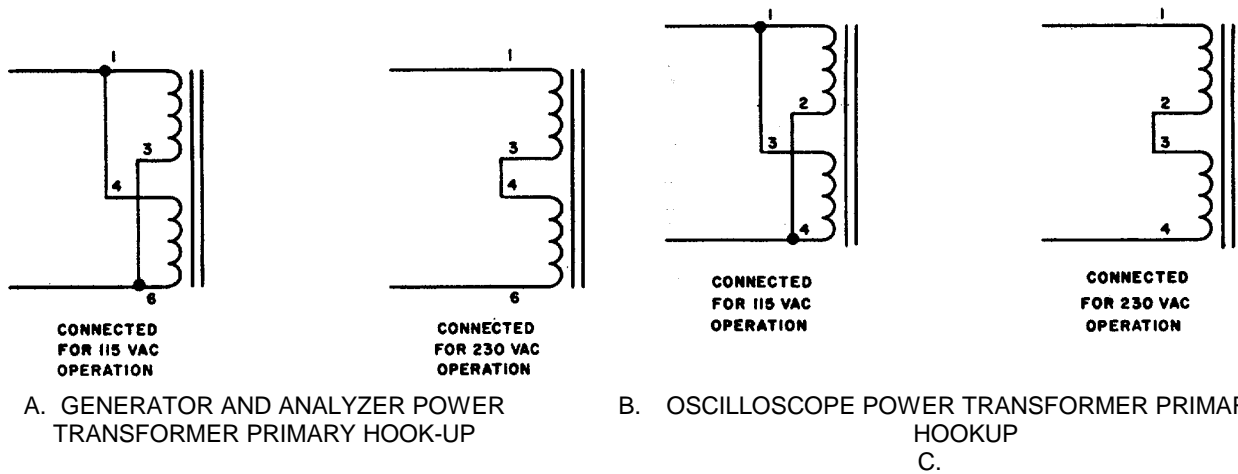

Figure 2-7. Power transformer strapping options.

- (2) Position the analyzer in the rack above the generator and secure with screws.
- (3) Position the oscilloscope above the analyzer and secure with screws.
- (4) Connect the interface cable to the rear of the units as illustrated in figure 2-9. Each plug on the cable is labeled with a reference designation that corresponds with the appropriate rear panel jack.

Connect as follows:

**NOTE**

It is important to make proper connections or damage may result.  
 3A4P2 to 3A4J2  
 2A3P3 to 2A3J3  
 1A3P2 to 1A3J2

- (5) Connect the power cables to the rear of the units as illustrated in figure 2-9. Three identical power cables are supplied and may be connected to the units in any order.

Connection is made to the following rear panel jacks:

- 3A4J1
- 2A3J4
- 1A3J4

**2-8. External Equipment Connections**

The following paragraphs detail the external equipment connections made to the test set for normal operation. Access to additional logic through the rear panel connectors is provided but not intended for use by the operator. Internal strapping options that affect the external equipment connections are discussed in chapter 3. For additional information see the appropriate technical manual.

a. *Generator.* External equipment connections affecting the generator are made as follows:

- (1) For high level polar operation, front or rear access, connect the positive battery lead to 1A3J3-16, the negative battery lead to 1A3J3-17, and battery common ground to 1A3J3-15. Set the P-N switch on the front panel to P (polar). Jumper 1A3J3-11 to 1A3J3-12 for front panel access through the DRY CONTACTS jack. Rear access is provided at 1A3J3-9. The marking sense is reversed by connecting the negative battery lead to 1A3J3-16 and the positive battery lead to 1A3J3-17 or by changing the internal strapping on assembly 1A2A2.

- (2) For high level neutral operation front panel access, set the P-N switch on the front panel to N (neutral) and jumper 1A3J3-11 to 1A3J3-12. For rear panel access, remove the jumper from 1A3J3-11 and 1A3J3-12 and connect the neutral loop to these two pins. The output is available at the DRY CONTACTS jack in both front and rear access configurations.

- (3) Externally stepped character release operation is accomplished by setting the CHARACTER RELEASE switch to EXT. and connecting a -60-volt dc step pulse at 2 ma to 1A3J3-6. The ground connection is made to 1A3J3-18. The repetition rate of the pulse must be related to the character length for the selected baud rate. For example) to step a signal at 50 baud requires that the minimum time between step pulses be 140 milliseconds.

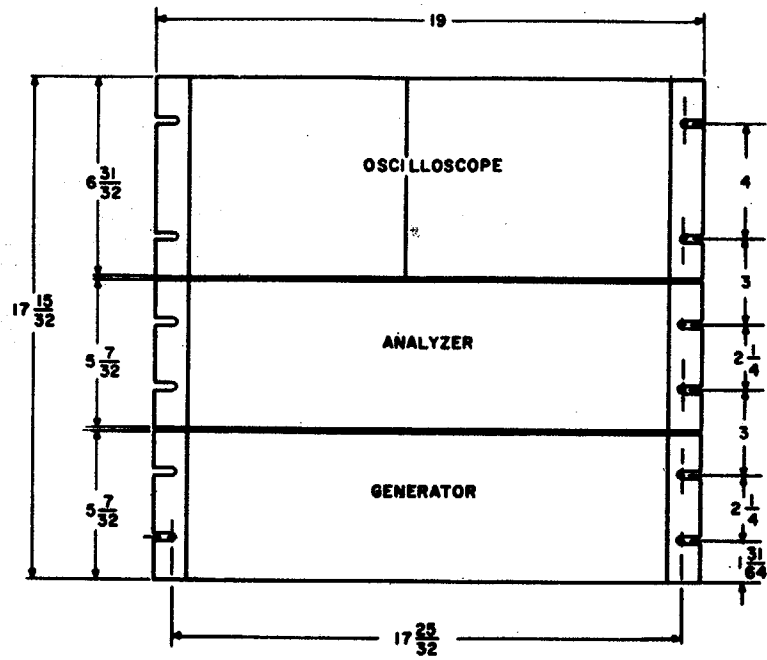

FRONT VIEW

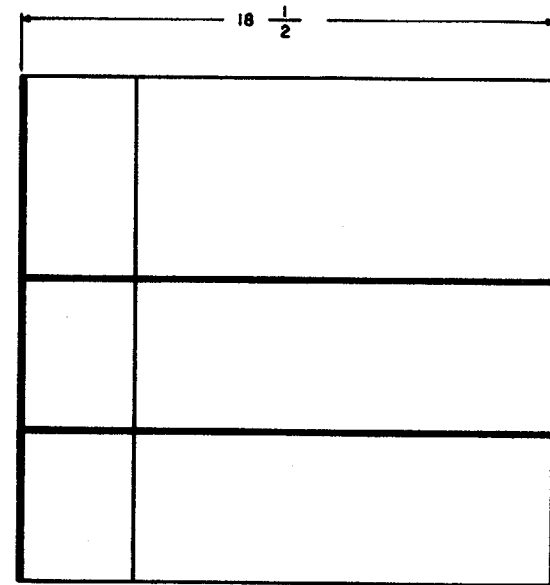

SIDE VIEW

EL6625-1668-12-TM-14

Figure 2-8. AN/GGM-15(V), mounting dimensions



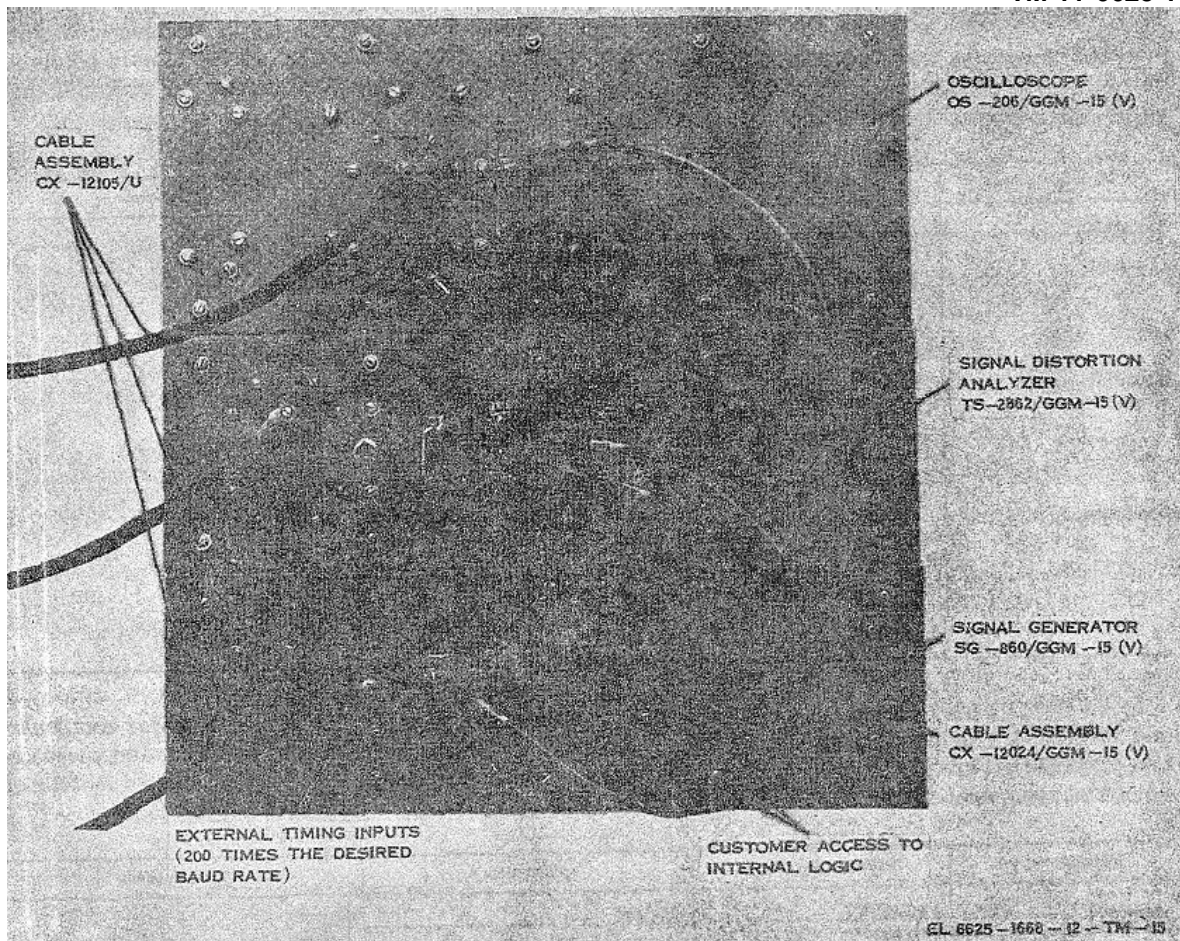

Figure 2-9. AN/GGM-15 (V), cable connections.

(4) An external timing source at 200 times the desired baud rate may be used when the BAUD RATE switch is set to EXT. and the external source at  $\pm 6$  volts is connected to 1A3J1 (BNC type connector, ground is shield). The generator may be synchronized with a station master clock at a frequency equal to 2 times the desired baud rate. The synchronizing signal at  $\pm 6$  volts is connected to 1A3J3-7. The ground connection is made at 1A3J3-18.

(5) Access to the low level data and clock outputs is provided at the DATA  $\pm 6/12V$  jack and the CLOCK  $\pm 6/12V$  jack on the front panel. The signal is at the jack tip. The sleeve provides the signal return. Rear access to the low level data is provided at 1A3J3-3 (signal) and 1A3J3 -4 (return).

*b. Analyzer.* External equipment connections affecting the analyzer are made as follows:

(1) For a bridging input, polar or neutral, connect the input ground to the BRIDGING input jack sleeve and the input signal to the BRIDGING input jack tip. Set the INPUT switch to Hz and the MARK POLARITY switch to + or-as determined by the mark polarity of the input signal.

(2) For series inputs connect the data signal to the SERIES input jack tip and data return to the sleeve. Set the INPUT switch to the position that indicates the current level and type of input signal. *For example:* 20N represents a 20-ma neutral loop.

(3) An external timing source at 200 times the desired baud rate may be used when the BAUD RATE switch is set to EXT. and the external source at  $\pm 6$  volts is connected to 2A3J1 (BNC type connector, ground is shield).

**2-9. Installation of Fuses and Crystals**

a. All fuses are installed at the factory. The fuses in each major component, their value, and reference designation are listed below. Figures 2-4, 2-5 and 2-6 will aid in locating most fuses. Other fuses are located on the plug-in assemblies (check reference designation for assembly number).

Major Component	Reference Designation	Value	Function
Generator .....	1A2A12F1 .....	1 AMP SLO-BLO .....	AC line.
	1A2A12F2 .....	1 AMP SLO-BLO .....	AC line.
	1A2A12F3 .....	3 AMP .....	+6 volts.
	1A2A12F4 .....	1/2 AMP .....	-6 volts.
	1A2A2F1 .....	1/4 AMP .....	Positive keyer.
	1A2A2F2 .....	1/4 AMP .....	Negative keyer.
Analyzer.....	2A2A9F1 .....	1 AMP SLO-BLO .....	AC line.
	2A2A9F2 .....	1 AMP SLO-BLO .....	AC line.
	2A2A9F3 .....	3 AMP .....	±6 volts.
	2A2A9F4 .....	1/2 AMP .....	-6 volts.
	2A2A6F1 .....	1/10 AMP .....	High level loop.
Oscilloscope.....	3A3F1.....	1/2 AMP SLO-BLO .....	AC line.
	3A3F2.....	1/2 AMP SLO-BLO .....	AC line.
	3A3F3.....	1/2 AMP .....	+15 volts.
	3A3F4.....	3/8 AMP .....	-15 volts.
	3A3A2F1 .....	1/10 AMP .....	+70 volts.
	3A3A2F2 .....	1/10 AMP .....	-70 volts.

b. All crystals with the exception of 1A2A11Y4 and 2A2A7Y4 are installed at the factory. The two crystals that are not installed are available as an option and used when the SPARE speed is selected. The crystals for each major component, their values, reference designation, and speeds for which the crystal is selected are listed as follows:

Major Component	Reference Designation	Value	Function
Generator .....	1A2A11Y1 .....	145.440.....	45.45
	1A2A11Y2 .....	195.584.....	61.12.
	1A2A11Y3 .....	1920.....	37.5, 50, 75, 150, 300, 600, 1200, 2400, 4800, 9600
	1A2A11Y4 .....	OPTIONAL .....	SPARE SPEED.
Analyzer.....	2A2A7Y1 .....	145.440.....	45.45.
	2A2A7Y2 .....	195.584.....	61.12.
	2A2A7Y3 .....	1920.....	37.5, 50, 75, 150, 300, 600, 1200, 2400, 4800,9600.
	2A2A7Y4 .....	OPTIONAL .....	SPARE SPEED.

**2-10. Initial Adjustment**

a. Set the analyzer POWER and oscilloscope PWR switches to OFF.

b. Check to see that the rear panel cable connections are made in accordance with the procedure in paragraph 2-6b.

**NOTE**

The use of the extender card for this procedure is optional. All adjustments are accessible with the 2A2A6 card in place, but the adjustments are more convenient with the extender inserted.

c. Open the front panel of the analyzer and remove 2A2A6 from its position.

d. Insert the extender card into the 2A2A6 position, and the 2A2A6 into the extender card.

e. Set the analyzer POWER switch and the oscilloscope PWR switch to ON.

f. Set the oscilloscope VERTICAL VOLTS (MA)/CM switch to 5 and the TRIGGER AND SWEEP SELECT switch to FREE RUN.

- g. Set the analyzer INPUT switch to BRIDGING V CAL.
- h. Adjust the oscilloscope VERT POS and VERTICAL VOLTS (MA)/CM VARIABLE controls for  $\pm 2$  cm deflection.
- i. Set the analyzer INPUT switch to I CAL and adjust 2A2A6-R11 to display equal deflection above and below the reference line.

**NOTE**

Be careful not to change the settings of the oscilloscope VERTICAL VOLTS (MA)/VARIABLE potentiometer for the rest of this procedure.

- j. Set the VERTICAL VOLTS (MA) /CM switch to 2.
- k. Set the analyzer INPUT switch to 20N.
- l. Connect Power Supply PP-3941/G to the SERIES INPUT jack and adjust for zero current (use sleeve as return).
- m. Adjust the oscilloscope VERT POS control to position the sweep to the zero center reference line on the graticule of the oscilloscope.
- n. Set the PP-3941/G output to 2 milliamperes (ma).
- o. The sweep should deflect one major vertical division (1 cm) on the graticule in the positive direction. If it does not, adjust R64 on assembly 2A2A6 to obtain the correct deflection.
- p. Repeat steps f and o above to insure the accuracy of the adjustment.
- q. Disconnect the PP-3941/G from the SERIES INPUT jack.
- r. Set the analyzer INPUT switch to ICAL.
- s. Set the oscilloscope VERTICAL VOLTS (MA) /CM switch to 5.
- t. The deflection on the crt must be plus (+) and minus (-) 2 cm. If it is not, adjust 2A2A6-R1 for the correct indication.
- u. Set the analyzer INPUT switch to 20N.
- v. Reconnect the PP-3941/G to the SERIES INPUT jack and check the oscilloscope calibration against the following chart:

VERT VOLTS (MA)/CM switch	PP-3941/G output current (ma)	Crt display deflection (cm)
2	$\pm 2$	$\pm 1$
5	$\pm 5$	$\pm 1$
10	$\pm 10$	$\pm 1$
20	$\pm 20$	$\pm 1$

- w. Set the analyzer INPUT switch to 60N.
- x. Set the PP-3941/G output to 80 ma.
- y. The crt should indicate exactly 1.6 cm. If it does not, adjust R62 on assembly 2A2A6 until the correct indication is obtained.

CHAPTER 3

OPERATION

Section I. OPERATING CONTROLS AND INDICATORS

3-1. General

This section contains a description of the operating controls and indicators, their position and function. The front panels of each major component are illustrated in figures 3-1, 3-2 and N The reference designations for each control and indicator are provided on the rear of the frond panels.

3-2. Generator Front Panel Controls, Indicators, and Connectors

Control, Indicator, or Connector	Function	
	Sw Pos	Connection
POWER (2-position toggle switch)	ON.....	Connects 115-volt 60-hertz operating power to unit. Disconnects operating power.
	OFF.....	
POWER (indicator lamp)	Lights when operating power is connected and POWER switch is ON.	
SIGNAL (indicator lamp)	Lights when output signal is marking.	
P-N (2-position toggle switch)	<i>Sw Pos</i>	
	P.....	Connects output circuit for polar operation.
	N.....	Connects output circuit for neutral operation.
PERCENT DISTORTION (Inner switch)	0-10-20-30-40 .....	Selects the percentage of distortion introduced into the output signal in 10% increments from zero to 40%.
	(Outer switch) 0 through 9 .....	Selects the percentage of distortion introduced into the output signal in 1% increments from zero to 9%.
DISTORTION -SELECT (6-position rotary switch)	NO DIST .....	No distortion is introduced to the output signal.
	BIAS M.....	Marking bias is introduced to the output signal.
	BIAS S .....	Spacing bias is introduced to the output signal.
	BIAS SW.....	Switching bias distortion is introduced to the output signal at all code levels in start-stop operation and 1:1 reversals.
	END S/M.....	Marking end distortion is introduced to the start-stop output signal only.
	<i>Sw Pos</i>	
	END S/SS .....	Spacing end distortion is introduced to the start-stop output signal only.
MESSAGE SELECT (6-position rotary switch)	SELECTED CHARACTER BITS	
	1:1 .....	Selects mark or space condition of intelligence bit elements 1 through 8 of selected character.
	MSG.....	Sets generator output to 1:1 reversals.
	M .....	Sets generator to transmit an 80- or 128-character fox message.
	S.....	Sets output to steady mark.
EXT .....	Sets output to steady space.	
CODE LEVEL (4 position rotary switch)	<i>Sw Pos</i>	
	5, 6, 7, 8 .....	Selects the number of intelligence bits in a character message.

Control, Indicator, or Connector	Function	
CHARACTER LENGTH (11-position rotary switch)	<i>Sw Pos</i>	<i>Connection</i>
	SYNC..... 7 to 16.....	Enables generator to produce synchronous signals (no start-stop pulse). Selects character length in bits from 7 to 16.
CHARACTER RELEASE (3-position toggle switch)	EXT.....	Permits control of character release by an external 60 volts 2 ma. pulse.
	FREE RUN.....	Permits release of characters in a free-running mode.
	MANUAL.....	Permits release of characters by the manual step switch.
SINGLE (2-position toggle switch, momentary make)	Releases one character at a time when the CHARACTER RELEASE switch is Bet to MANUAL (start-stop only).	
BAUD RATE (14-position rotary switch)	<i>Sw Pos</i>	<i>Connection</i>
	37.5 to 9600..... EXT (200X).....	Selects any one of 12 baud rates plus a spare. Permits use of external timing at 200 times desired baud speed.
OSC (2-position toggle switch)	INT..... EXT (2X).....	Selects internal oscillator for time base. Provides for external timing input at 2 times the baud rate.
ALARM (3-position toggles switch, momentary RESET)	RESET..... ON..... DISABLE.....	Resets the alarm circuit to normal. Permits alarm circuit to operate. Disables alarm circuit.
OSC FAILURE (indicator lamp)	Lights when clock oscillator fails or divider board is not working.	
DRY CONTACTS (output jack)	Tip..... Sleeve.....	Tongue. Battery return.
DATA ±6/12V (Output jack)	Tip..... Sleeve.....	Low level data. Low level data return.
CLOCK ±6/12V (Output jack)	Tip..... Sleeve.....	Low level clock. Low level clock return.

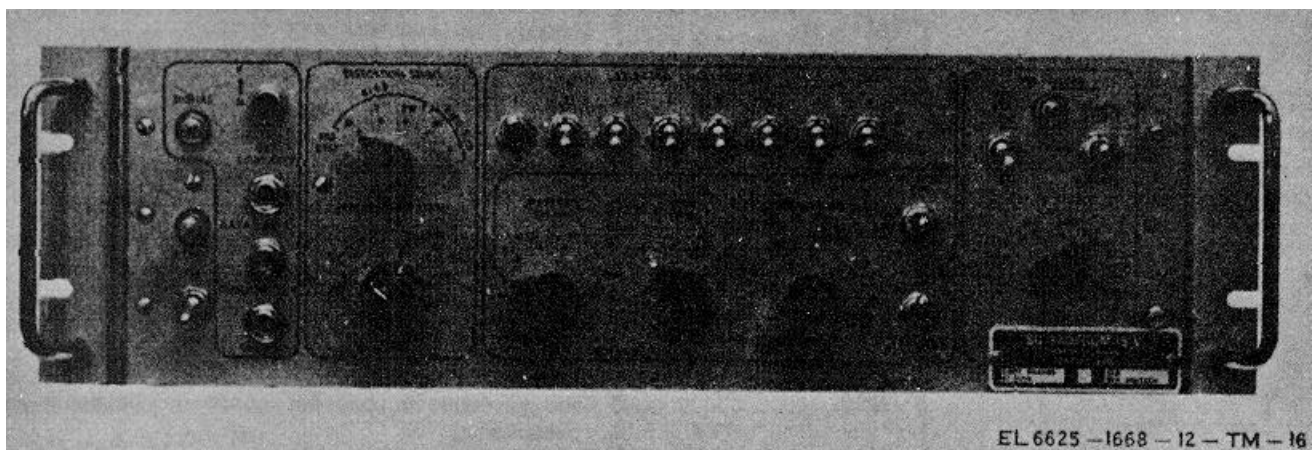

Figure 3-1. SG-860/GGM-15(V), controls and indicators.

3-3. Analyzer Front Panel Controls, Indicators, and Connectors

Control, Indicator, or Connector	Function	
POWER (2-position toggle switch)	<i>Sw Pos</i>	<i>Connection</i>
	ON..... OFF.....	Connects 115-volt 60-hertz operating power to the analyzer. Disconnects operating power.
POWER (indicator lamp)	Lights when operating power is connected and POWER switch is ON.	
SIGNAL (indicator lamp)	Lights when output signal is marking.	
MARK POLARITY (2-position toggle switch)	<i>Sw Pos</i>	<i>Connection</i>
	+ -	Positions mark pulse positive. Positions mark pulse negative.
OVERFLOW (indicator lamp)	Lights when errors or hits exceed 99 as indicated by nixie lamps.	
RESET (2-position toggle switch)	<i>Sw Pos</i>	<i>Connection</i>
	AUTO..... MAN.....	Resets nixie display at 3 to 5 seconds intervals. Resets nixie indicator lamps to zero.
DISPLAY MODE (5-position rotary switch)	TEST MODE.....	Connects error code to generator for addition of desired distortion and further introduces two errors for each error code cycle (2047 bit times).
	DIST (%).....	Normal operating position for analyzing average distortion, peak distortion on start-stop and synchronous data.
	ERROR RATE (HITS/10n) 10 <sup>3</sup> .....	Normal position for detecting errors on an incoming error pattern for a time duration of 1,000 bits.
	ERROR RATE (HITS/10n) 10 <sup>6</sup> .....	Normal position for detecting errors in an incoming error pattern for a time duration of 1,000,000 bits.
	PEAK MON (HITS).....	Counts the numbers of transitions on incoming data which exceed the selected limit on the THRESHOLD % DISTORTION dials.
THRESHOLD (Thumbwheel switches)	Selects error rate and peak monitor threshold.	
MARK-FINISH (Indicator lamp)	Lights when average distortion is of the marking type or when the 10s or 106 time is completed in the error analysis mode.	
SPACE-START (Indicator lamp)	Lights when average distortion is of the spacing type and at the start of 10s or 106 time for error analysis.	
INPUT (7-position rotary switch)	<i>Sw Pos</i>	<i>Connection</i>
	SERIES 60N.....	Connects loop to 60-ma neutral input circuits through SERIES INPUTS jack.
	SERIES 20N.....	Connects loop to 20-ma neutral input circuits through SERIES INPUTS jack.
	SERIES 20P.....	Connects loop to polar input circuits (2 ma to 20 ma) through SERIES INPUTS jack.
	SERIES 30P.....	Connects loop to polar input circuits (2 ma to 30 ma) through SERIES INPUTS jack.
	SERIES ICAL.....	Used for current calibration of oscilloscope.
	BRIDGING HIZ.....	Provides connection to high impedance input circuits through BRIDGING INPUTS jack.
BRIDGING.....	Used for voltage calibration of oscilloscope.	
CODE LEVEL (5-position rotary switch)	SYNC.....	Permits measurement of synchronous data signals.
	5, 6, 7, 8.....	Permits measurement of 5, 6, 7, or 8-level start-stop signals.
FILTER (2-position toggle switch)	IN.....	Connect input signal to filter to remove small noise impulses before analysis on speeds to 150 bauds.

Control, Indicator, or Connector	Function	
	Sw Pos	Connection
TRANSITION (10-position rotary switch)	OUT .....	Disconnects filter from circuit.
	ALL.....	Permits analysis of all transitions.
	1 through 9.....	Selects an individual transition in a character for analysis
DISTORTION (6-position rotary switch)	AVG BIAS S/M.....	Permits analysis of average distortion on space-to-mark transitions.
	AVG END M/S .....	Permits analysis of average distortion on, mark-to-space transitions.
	PEAK TOTAL .....	Permits analysis of total peak distortion.
	PEAK EARLY.....	Permits analysis of early peak distortion.
	PEAK LATE .....	Permits analysis of late peak distortion.
BAUD RATE (14-position rotary switch)	37.5 through 9600 .....	Selects any one of 12 baud rates plus a spare.
	EXT (220X) .....	Permits use of external timing at 200 times desired baud speed.
CLOCK (indicator lamp)		Lights when internal or external 200X oscillator fails.
ALARM (8-position toggle switch, Momentary RESET)	RESET .....	Resets audible and visual alarm circuit to normal.
	ON.....	Allows audible and visual alarm circuit to operate.
	DISABLE.....	Disables audible and visual alarm circuit.
BRIDGING	Tip.....	HIZ and VCAL input circuits.
	Sleeve.....	HIZ and VCAL return.
SERIES	Tip.....	60N, 20N, 20P, 30P and ICAL input circuits.
	Sleeve.....	60N, 20N, 20P, 30P and ICAL return.

**3-4. Oscilloscope Front Panel Controls and Indicators**  
(fig. 34)

Control, Indicator, or Connector	Function	
	Sw Pos	Connection
VERTICAL VOLTS (MA)/CM (6-position rotary switch) Caution: Do not apply 200 ma current at 200 (volts only) setting. Series input circuits limited to 100 ma.	2, 5, 10, 20, 50, 200 VOLTS ONLY	Permits selection of vertical deflection sensitivity for voltage or current for CRT display on all ranges except 200, where only voltage is displayed.

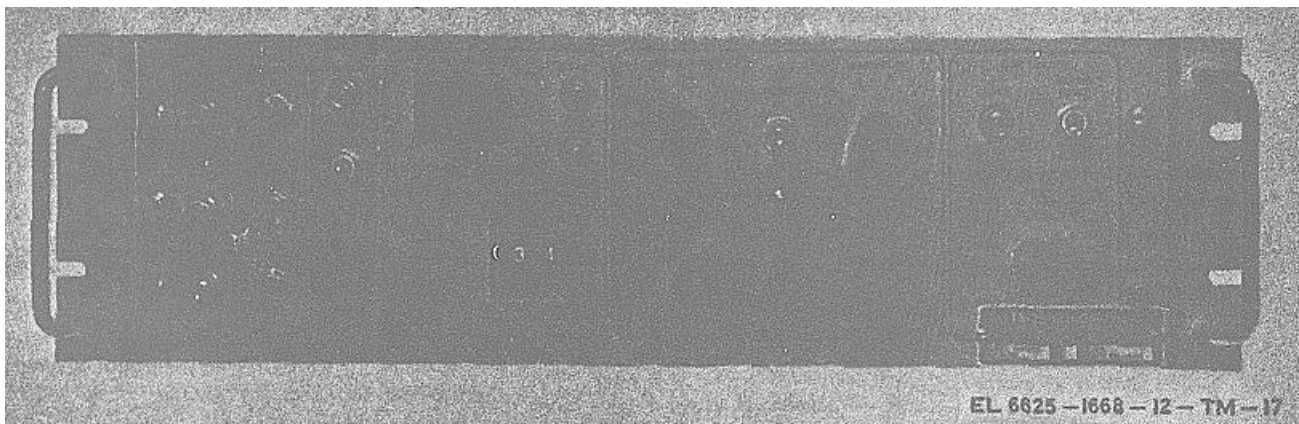

Figure 3-2. TS-2862/GGM-15 (V), controls and indicators.

Control, Indicator, or Connector	Function										
<p>VARIABLE (adjustable concentric potentiometer, used in conjunction with VERTICAL VOLTS (MA)/CM switch).</p>	<p>Used for calibration of VERTICAL VOLTS (MA)/CM ranges.</p>										
<p>VERT POS (adjustable potentiometer)</p>	<p>Provides vertical position control of CRT signal display pattern.</p>										
<p>FOCUS (adjustable potentiometer)</p>	<p>Used for focusing the CRT trace to a fine line pattern.</p>										
<p>Z MARKERS (2-position toggle switch)</p>	<table border="0" style="width: 100%;"> <tr> <td style="width: 50%; text-align: center;"><i>Sw Pos</i></td> <td style="width: 50%; text-align: center;"><i>Connection</i></td> </tr> <tr> <td>ON.....</td> <td>Provides markers for each transition on CRT display.</td> </tr> <tr> <td>OFF.....</td> <td>Removes transition markers from CRT display.</td> </tr> </table>	<i>Sw Pos</i>	<i>Connection</i>	ON.....	Provides markers for each transition on CRT display.	OFF.....	Removes transition markers from CRT display.				
<i>Sw Pos</i>	<i>Connection</i>										
ON.....	Provides markers for each transition on CRT display.										
OFF.....	Removes transition markers from CRT display.										
<p>ASTIG (adjustable potentiometer)</p>	<p>Provides a sharper CRT display pattern. (Used in conjunction with the FOCUS control.)</p>										
<p>INTENSITY CRT (adjustable potentiometer)</p>	<p>Provides intensity control of CRT display.</p>										
<p>INTENSITY SCALE (adjustable potentiometer concentric with CRT potentiometer)</p>	<p>Provides graticule illumination control.</p>										
<p>HORIZONTAL GAIN (adjustable potentiometer)</p>	<p>Provides control of horizontal gain.</p>										
<p>HORIZONTAL POSITION (adjustable potentiometer, concentric with GAIN potentiometer)</p>	<p>Provides horizontal position control of CRT signal display pattern.</p>										
<p>DISPLAY RELEASE RATE (8-position rotary switch)</p>	<table border="0" style="width: 100%;"> <tr> <td style="width: 50%; text-align: center;"><i>Sw Pos</i></td> <td style="width: 50%; text-align: center;"><i>Connection</i></td> </tr> <tr> <td>VARIABLE .....</td> <td>Provides variable sweep release.</td> </tr> <tr> <td>NORMAL.....</td> <td>Provides normal sweep release.</td> </tr> <tr> <td>MAN .....</td> <td>Enables manual sweep release.</td> </tr> </table>	<i>Sw Pos</i>	<i>Connection</i>	VARIABLE .....	Provides variable sweep release.	NORMAL.....	Provides normal sweep release.	MAN .....	Enables manual sweep release.		
<i>Sw Pos</i>	<i>Connection</i>										
VARIABLE .....	Provides variable sweep release.										
NORMAL.....	Provides normal sweep release.										
MAN .....	Enables manual sweep release.										
<p>SINGLE (spring loaded toggle switch in conjunction with DISPLAY RELEASE RATE switch in MAN position)</p> <p>TRIGGER &amp; SWEEP SELECT (8-position rotary switch)</p>	<table border="0" style="width: 100%;"> <tr> <td style="width: 50%; text-align: center;"><i>Sw Pos</i></td> <td style="width: 50%; text-align: center;"><i>Connection</i></td> </tr> <tr> <td>SINGLE.....</td> <td>Releases a single sweep when DISPLAY RELEASE RATE switch is set to ON.</td> </tr> <tr> <td>AUTO.....</td> <td>Selects synchronous, digital sweep.</td> </tr> <tr> <td>FREE RUN .....</td> <td>Stops trigger and sets re sweep to FREE RUN.</td> </tr> <tr> <td>INT (EXT TRIG).....</td> <td>Switches re sweep to external trigger operation.</td> </tr> </table>	<i>Sw Pos</i>	<i>Connection</i>	SINGLE.....	Releases a single sweep when DISPLAY RELEASE RATE switch is set to ON.	AUTO.....	Selects synchronous, digital sweep.	FREE RUN .....	Stops trigger and sets re sweep to FREE RUN.	INT (EXT TRIG).....	Switches re sweep to external trigger operation.
<i>Sw Pos</i>	<i>Connection</i>										
SINGLE.....	Releases a single sweep when DISPLAY RELEASE RATE switch is set to ON.										
AUTO.....	Selects synchronous, digital sweep.										
FREE RUN .....	Stops trigger and sets re sweep to FREE RUN.										
INT (EXT TRIG).....	Switches re sweep to external trigger operation.										
<p>TIME MILLISEC (4-position rotary switch)</p>	<p>0.05 to 500 .....</p> <p>Selects sweep time duration for FREE RUN and INT (EXT TRIG) modes of TRIGGER &amp; SWEEP SELECT SWITCH.</p>										
<p>VARIABLE (adjustable potentiometer)</p>	<p>Adjusts potentiometer for TIME MILLISEC switch.</p>										
<p>POWER ((2-position toggle switch)</p>	<table border="0" style="width: 100%;"> <tr> <td style="width: 50%; text-align: center;"><i>Sw Pos</i></td> <td style="width: 50%; text-align: center;"><i>Connection</i></td> </tr> <tr> <td>ON.....</td> <td>Connects 115-volt 60-hertz operating power to the oscilloscope.</td> </tr> <tr> <td>OFF.....</td> <td>Disconnects operating power.</td> </tr> </table>	<i>Sw Pos</i>	<i>Connection</i>	ON.....	Connects 115-volt 60-hertz operating power to the oscilloscope.	OFF.....	Disconnects operating power.				
<i>Sw Pos</i>	<i>Connection</i>										
ON.....	Connects 115-volt 60-hertz operating power to the oscilloscope.										
OFF.....	Disconnects operating power.										
<p>POWER (indicator lamp)</p>	<p>Lights when operating power is applied and POWER switch is ON.</p>										



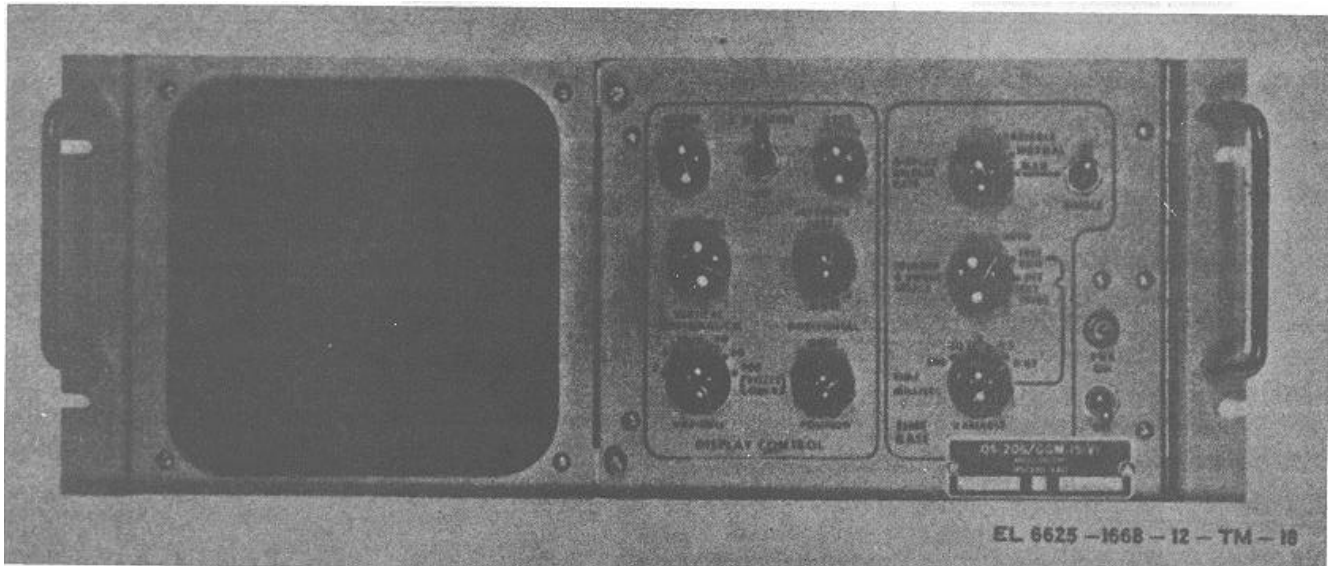

Figure 3-3. OS206/GGM-15 (V), controls and indicators.

## Section II. OPERATING PROCEDURES

### 3-5. General

This section contains a description of the types of telegraph distortion that the operator may encounter, the modes of operation, including strap option information and typical operating procedures.

### 3-6. Types of Distortion

a. The basic types of distortion are marking-bias distortion, spacing-bias distortion, marking-end distortion and spacing-end distortion. Bias distortion is that which results in the displacement of the space-to-mark transition. End distortion is that type of distortion which causes the displacement of the relative mark-to-space transition to the first mark-to-space signal transition (start pulse) with no significant effect on the space-to-mark transition. End distortion is associated with start-stop signals only. These types of distortion are illustrated in figure 3-4.

b. Bias distortion is called marking bias when the transition from space-to-mark occurs early, resulting in the lengthening of following marking interval. The distortion is called spacing bias when the space-to-mark transition occurs late and lengthens the preceding space interval. End distortion is called marking end when the transition from mark-to-space occurs late, resulting in the previous marking interval being lengthened. The distortion is called spacing end when the mark-to-space transition occurs early and lengthens the following space interval.

c. Other types of distortion encountered are characteristic distortion, fortuitous distortion, cyclic distortion, and speed distortion. Characteristic distortion results from electrically long circuits which do not allow the signal to reach steady-state conditions within 1 bit time. Characteristic distortion may also result from narrow bandwidth on carrier circuits. Fortuitous distortion is intermittent and is the random displacement splitting or breakup of the mark and space elements. It is caused by many factors such as loop battery fluctuations, primary power fluctuations, radio path fading, etc., and may occur in addition to bias or end distortion. Cyclic distortion is considered a type of distortion which varies at a predictable rate. For instance, if bias distortion were to be measured, and a reading of 5% were obtained initially, cyclic distortion could cause this reading to advance to 10% and then back down to 5% over a period of time at a fairly constant rate. Speed distortion will result if the speed of the incoming signal and the speed of the analyzer are not the same. Speed distortion will be represented as bias and/or end distortion: marking-bias or spacing-end distortion if the incoming signal speed is faster than the analyzer operating speed; and as spacing-bias or marking-end distortion if the incoming signal speed is slower than the operating speed. The distortion increases uniformly from bit to bit within a character. The amount of speed error in percent is one-fifth of the increase in distortion reading from the first transition to the sixth transition. *For example*, a 5 percent increase of marking bias from the first to the sixth bit within a character would indicate that the incoming signal speed is 1 percent fast.

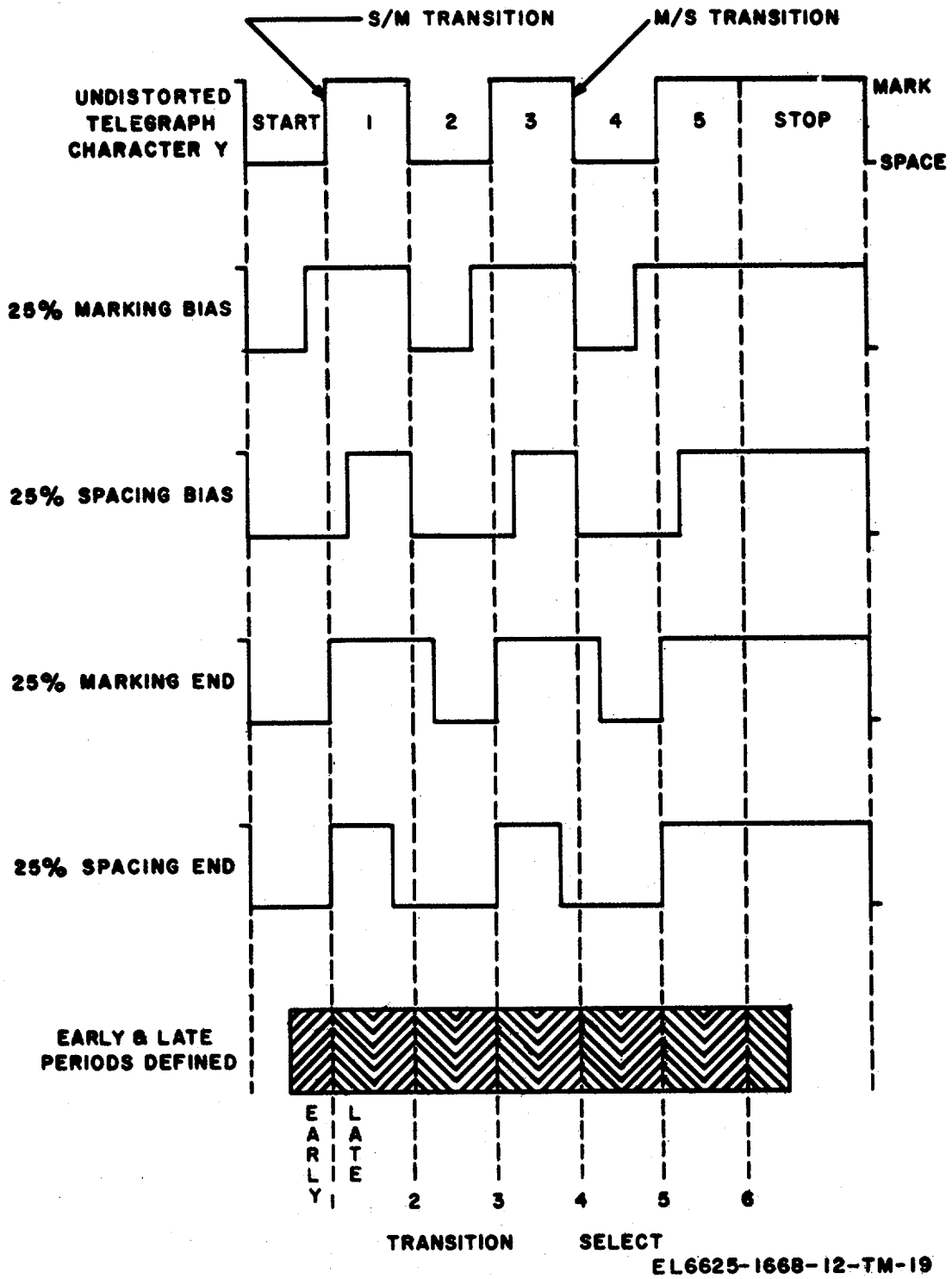

Figure 3-4. Types of distortion.

**3-7. Generator Operating Procedure**

The operating procedure for the generator is presented with a description of the many operating modes and types of output signals. In order to familiarize the operator with the numerous controls and switches, examples have been prepared of the various operating modes, listing the positions of all switches, and conditions required to perform these operations.

a. *Generator SG-860/GGM-15(V) Preliminary Starting Procedure.* Perform the preliminary starting procedures listed below before attempting to use the AN/GGM-15(V) operate only those panel controls that are listed. Do not apply power to unused units.

- (1) Check power and interface cable connections (fig. 2-9).
- (2) Connect the generator to the correct ac power source (para 2-7).
- (3) For a preliminary test of the generator set the controls as follows:

<i>Control</i>	<i>Position</i>	<i>Control</i>	<i>Position</i>
PWR .....	OFF	MESSAGE SELECT switch .....	M
P-N switch .....	N (neutral)	CODE LEVEL switch.....	5
DISTORTION SELECT switch .....	No DIST	CHARACTER LENGTH switch .....	8
PERCENT DISTORTION switches.....	0-0	CHARACTER RELEASE switch .....	FREE RUN
SELECTED CHARACTER BITS	1 to M	SINGLE switch .....	Not used
switches.....	2 to M	OSC switch.....	INT
	3 to S	ALARM switch .....	DISABLE
	4 to S	BAUD RATE switch.....	75
	5 to S		

**NOTE**

The position of unmentioned controls will not affect operation in this mode.

- (a) Connect adapter 1A3P3 to 1A3J3
- (b) Connect a patch cord from the DRY CONTACTS output jack to the external neutral loop. The connections to the Loop Battery Supply are illustrated in figure 3-5.
- (c) Connect a patch cord from the equipment under test to the neutral loop as illustrated.
- (d) Set the generator and power supply POWER switches to ON and adjust the loop current to 60 milliamperes.
- (e) Set the MESSAGE SELECT switch to SELECTED CHARACTER BITS.
- (f) The generator will transmit the letter A repetitively.
- (g) The SIGNAL indicator lamp illuminates each time the output signal is marking. (The SIGNAL indicator lamp requires at least 50 volts to illuminate.)

b. *Generator Modes of Operation (Selected Character Bits).*

(1) *Synchronous.* The generator will produce a synchronous pattern when the CHARACTER LENGTH switch is set to SYNC. With the CHARACTER LENGTH switch in the SYNC position the start and stop pulses are deleted. The SELECTED CHARACTER BITS switches are used to generate a repetitive 5, 6, 7 or 8 element synchronous pattern.

(2) *Start-stop.* The generator will transmit a Start-Stop character consisting of 5, 6, 7 or 8 bit lengths by setting the MESSAGE SELECT SWITCH to the SELECTED CHARACTER BITS position and the CODE LEVEL switch to the desired setting. To select a particular character for a five-level code the SELECTED CHARACTER BITS switches 1 through 5 are set to mark or space in accordance with the alphabetic character desired. (See Baudot alphabet or ASCII code in figure 3-6). The CODE LEVEL switch is placed in position 5.

The above settings will produce a five-level code consisting of five information bits plus a start and a stop pulse or a character length of 7. Thus, with the CODE LEVEL switch in position 5 and the CHARACTER LENGTH switch at 7, the generator will produce an undistorted character of seven equal bits in width. If the CODE LEVEL switch is moved to position 6 and the CHARACTER LENGTH switch is moved to 8, an undistorted character will now consist of six information bits plus a start and a stop bit (a total of 8 bits) all of equal widths. However, if the CODE .LEVEL switch remains at 6 and the CHARACTER LENGTH switch is moved to 7, the generator

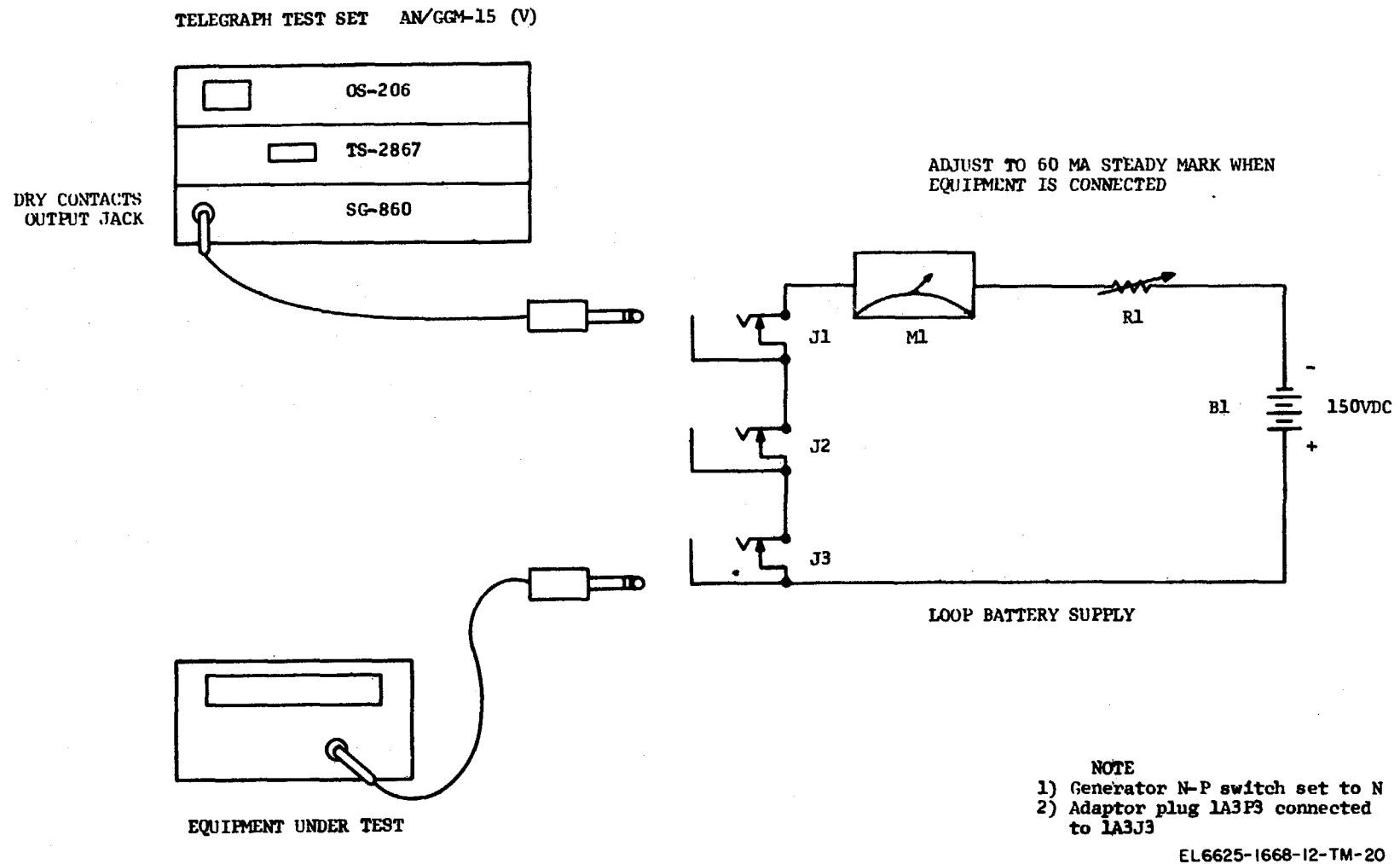

Figure 3-5. Free-run message operation (high level neutral).



length of 8 (six information bits plus a start and stop pulse) all of equal widths. Under these conditions the CODE LEVEL switch will override the CHARACTER LENGTH switch. If, on the other hand, the CODE LEVEL switch remains at 6 but the CHARACTER LENGTH switch is moved to 9, the character will consist of six information bits and a start pulse all equal to each other in width with the exception of stop pulse which will then be two bits wide. To summarize the functions of the CODE LEVEL and CHARACTER LENGTH switches, a character is always two more pulses than indicated on the CODE LEVEL switch. Increasing the position of the CHARACTER LENGTH switch increases the length of the stop pulse.

(3) *Free Run Selected Character Operation.* The following is typical of a free run selected character transmission operating procedure. For purposes of this procedure 22% spacing bias distortion is introduced to the output signal and a 150-volt, 60-ma neutral loop supply is keyed (fig. 3-7). Assume 150-baud operation.

Control	Position	Control	Position
P-N switch.....	P (Polar)	MESSAGE SELECT switch.....	M
DISTORTION SELECT switch.....	BIAS S	CODE LEVEL switch.....	5
PERCENT DISTORTION switches.....	2	CHARACTER LENGTH switch.....	8
SELECTED CHARACTER BITS	1 to M	CHARACTER RELEASE switch.....	FREE RUN
switches.....	2 to M	OSC switch.....	INT
	3 to S	BAND RATE switch.....	150
	4 to S		
	5 to S		

**NOTE**

The position of unmentioned controls will not affect operation in this mode.

(a) Connect the power supply return to pin 15, +60 volts to pin 16 and -60 volts to pin 17 of connector 1A3P3.

(b) Connect adapter 1A3P3 to connector 1A3J3.

(c) Connect a patch cord from the DRY CONTACTS output jack to the equipment under test.

(d) Set the generator POWER switch to ON.

(e) Set the power supply POWER switch to ON and adjust the loop current for 20 ma.

(f) Set the MESSAGE SELECT switch to the SELECTED CHARACTER BITS position.

(g) The generator will transmit the letter A repetitively.

(h) The SIGNAL indicator lamp illuminates each time the output signal is marking, as the selected character is generated (requires at least 50-volt polar signal to light the neon lamp).

(4) *1:1 reversals.* A continuous pattern of 1:1 reversals may be obtained at the output of the generator by setting the MESSAGE SELECT switch to the 1:1 position. The 1:1 signal can be distorted by marking, spacing or switching bias. The percent distortion introduced to the signal is obtained by the combined settings of the PERCENT DISTORTION switches.

(5) *MSG: (internal).* With the MESSAGE SELECT switch set to MSG, the generator will transmit either an 80-character or 128-character test message as determined by the position of the strap in the character counter, assembly 1A2A8. The strap positions are clearly marked on the assembly when shipped from the factory. The standard test message provided with the generator is in 5-level Baudot code, an 8-level message is available as an option. Distortion is introduced to the message by setting the BIAS-END switch to the appropriate position, marking bias (BIAS-M) spacing end (END-S). The maximum amount of distortion that can be introduced by generator is 49 %. This distortion is controlled by the combined settings of the PERCENT DISTORTION switches. One switch controls the distortion in 10% increments from 0 to 40% and the other switch provides distortion in 1% increments from 0 to 9%.

(6) *M (steady mark) S (steady space).* A steady mark or a steady space output signal is selected by means of the MESSAGE SELECT switch. With this switch in the S position a steady space signal is provided at the output. With the MESSAGE SELECT switch in the M position a steady mark signal is produced. All other switches are inoperative for steady mark or steady space transmission.

(7) *EXT (external message operation).* With the generator MESSAGE SELECT switch set to EXT, and the analyzer DISPLAY MODE switch set to ERROR TEST, the pseudo-random test pattern from the analyzer is applied to the generator through the rear panel connector and back to the analyzer for system self-test. The system self-test is performed as part of the maintenance procedures (para 4-10).

TELEGRAPH TEST SET

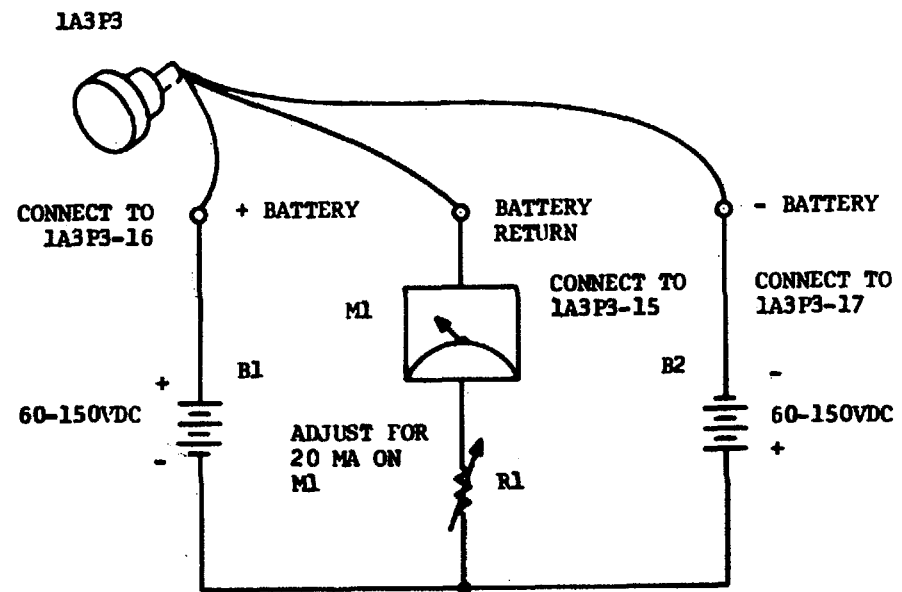
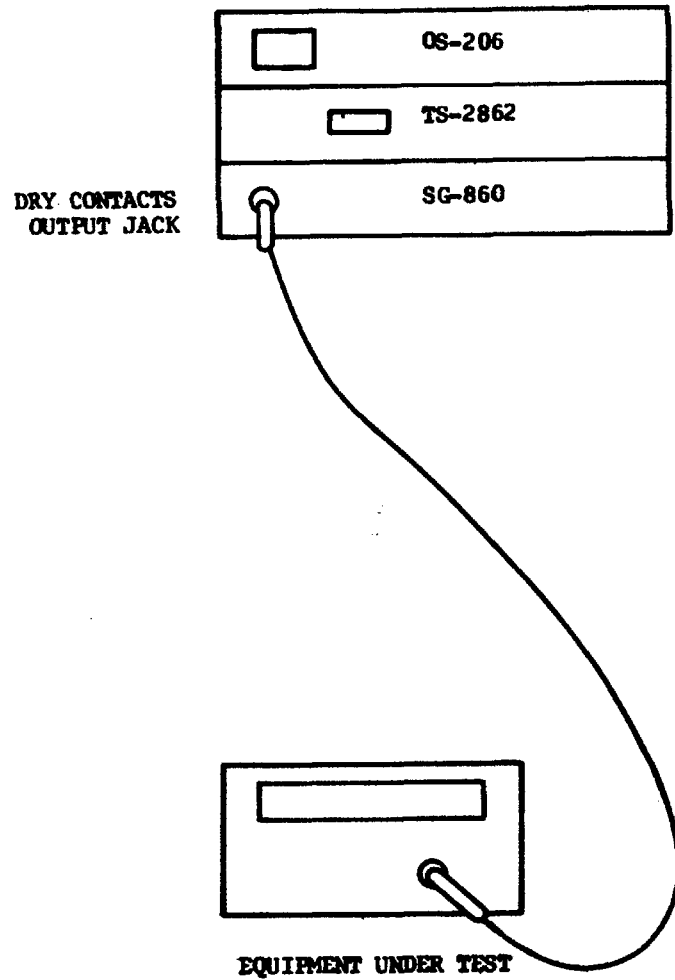

- NOTE**
- 1) Pin 1A3P3-11 must be jumpered to 1A3P3-12
  - 2) N-P switch is set to P

EL6625-1668-12-TM-22

Figure 3-7. Free run selected character operation (high level).

(8) *Typical EXT message operation.* The following is a typical example of an external (free run) message operation. For the purpose of this procedure 25% switching bias distortion is introduced to the message. The output signal applied to the equipment under test is low level  $\pm 6$  volts polar (fig. 3-8).

Set the generator controls as follows:

Control	Position	Control	Position
P-N switch.....	P (Polar)	CODE LEVEL switch.....	5
DISTORTION SELECT switch.....	BIAS switch	CHARACTER LENGTH switch.....	8
PERCENT DISTORTION switches.....	25	CHARACTER RELEASE switch.....	FREE RUN
SELECTED CHARACTER BITS switches.....	M (all switches)	Single switch.....	INT
MESSAGE SELECT switch.....	Ext	Alarm switch.....	DISABLE
		BAUD RATE switch.....	1200

**NOTE**

During external message operation the SELECTED CHARACTER BITS, CODE LEVEL, and CHARACTER LENGTH switches have no effect on the generator output.

(a) Connect the external message data signal from the analyzer at 2A3J2 pin 1 and 2A3J2 pin 15 (ground) to the generator rear panel connector 1A3J2 pin 1 and at 1A3J2 pin 3 (ground).

(b) Connect a patch cord from the DATA  $\pm 6/12V$  generator OUTPUT jack to the equipment under test.

(c) Set the POWER switch to ON.

(d) The regenerated and distorted external message is applied to the equipment under test. (The signal indicator lamp does not illuminate for low level output keying.)

*c. Character Release Operation.*

(1) *EXT (stepped).* For stepped operation the CHARACTER RELEASE switch must be set to the EXT position. This enables externally applied step pulses to release each character. Each time a suitable step pulse occurs a character is released. After a particular character is released it remains in its stop pulse period until a new character is released. Thus a stop pulse period is a function of the step pulse. The amplitude of the external step pulse must be -60 volts dc at 2 ma and is applied to connector 1A3J3 at pin 6.

(2) *FREE RUN.* The generator operates in the free run mode when CHARACTER RELEASE switch is set to FREE RUN. During this mode of operation, the output signal from the generator is determined by the MESSAGE SELECT switch and can be either a selected character, 1:1 reversals, test message, steady mark, steady space, or EXT (an externally applied pseudo-random test pattern).

(3) *MANUAL.* For manual character release set the CHARACTER RELEASE switch to MANUAL. The SINGLE switch is of the spring return type, a character is released by depressing and releasing the SINGLE switch. With the MESSAGE SELECT switch in SELECTED CHARACTER the generator will release one character with each depression and release of the switch. With the SELECTED CHARACTER switch in the MSG position, operation of the SINGLE switch will generate one character (one letter) from the 80-character message.

*d. Outputs*

(1) *Low level DATA  $\pm 6/12$ .* The low level output circuit is a solid-state polar output which provides signals with amplitudes of  $\pm 6$  or  $\pm 12$  volts. The voltages for the low level output are furnished internally from the generator power supply. The low level output is available from the front panel only, from the rear panel only, or combined front and rear. The front panel low level output is designated DATA  $\pm 6/12$  volts.

(2) *Low level CLOCK  $\pm 6/12V$ .* A clock out-put signal is provided as a timing source for external synchronous data systems. The clock is a polar signal with an amplitude of  $\pm 6$  or  $\pm 12$  volts. Clocking signals occur at twice the baud rate and are available for speeds up to 9600 baud. Normal factory strapping is  $\pm 6$  volts.

(3) *High level, DRY CONTACTS.* The high level output circuit is a solid-state output available from the front and rear panel only. When shipped from the factory, the generator is strapped for combined front and rear access. The front pane) output for high level signal is designated DRY CONTACTS. An external power supply is required to furnish the battery for the high level loops. The external high level output will key with any battery from .5 volt to 150 volts with a maximum current of 100 ma. The P-N switch will provide a high level polar output when in the P position and a high level neutral output when in the N position.

*e. Generator Strap Options.* Strapping options are available in the generator to accomplish addi-



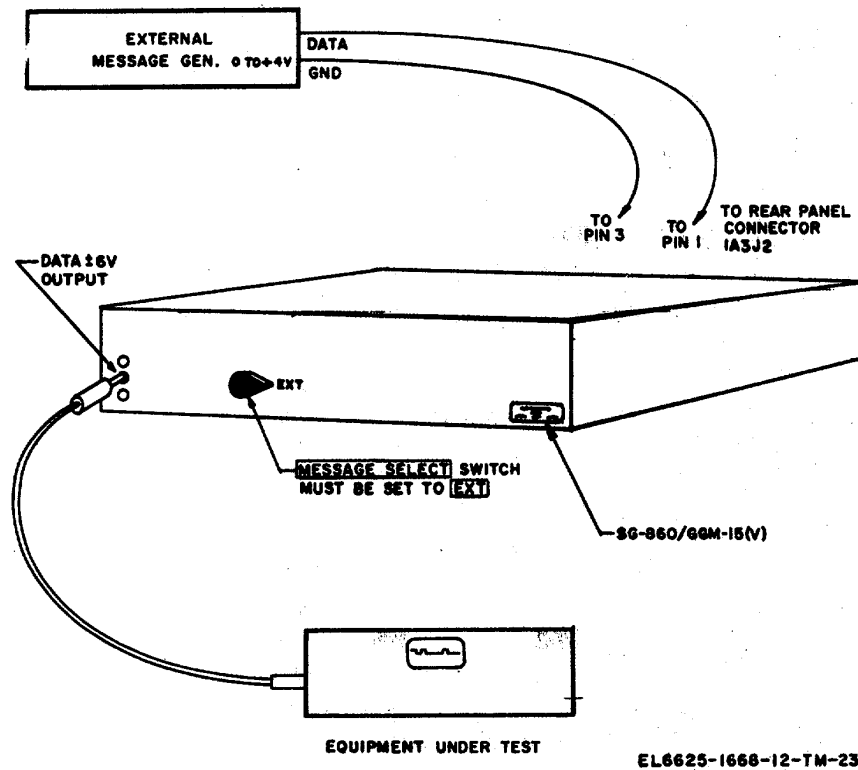

Figure 3-8. External message test setup.

tional functions, however, the actual changes to the circuitry can only be accomplished at a general support or depot level maintenance facility.

**3-8. Analyzer Operating Procedures**

The operating procedures contained in this paragraph must be read before attempting to operate the analyzer. A description of each control function and a typical operating procedure are provided as an aid to the operator.

*a. Analyzer TS-2862/GGM-15(V), Preliminary Starting Procedure.*

- (1) Check power and interface cable connections (fig. 2-9).
- (2) Connect the analyzer to the correct ac power source (para 2-6).
- (3) For a preliminary test of the analyzer set the controls as follows: The analyzer can be tested against Generator SG-860/GGM-15V.

Control	Position
POWER switch.....	OFF
MARK POLARITY switch.....	(Negative position)
RESET switch.....	OFF
DISPLAY MODE switch .....	DIST (%)
THRESHOLD % DISTORTION switch	00
CODE LEVEL switch .....	5

Control	Position
INPUT switch.....	HIZ
FILTER switch .....	OUT
TRANSITION switch .....	ALL
DISTORTION switch.....	AVG BIAS S/M
ALARM RESET.....	DISABLE
BAUD RATE .....	1200

Set the generator controls as follows:

Control	Position
POWER .....	OFF
P-N switch.....	P (polar)
DISTORTION SELECT switch .....	BIAS M

Control	Position
PERCENT DISTORTION switches ...	25%
MESSAGE SELECT switch.....	MSG
CODE LEVEL switch.....	

Control	Position
CHARACTER LENGTH switch.....	8
SINGLE switch .....	(Not used)
OSC switch .....	INT

Control	Position
ALARM switch.....	DISABLE
BAUD RATE switch.....	1200

- (a) Connect a patch cord from the DATA ±6V OUTPUT jack of the generator to the BRIDGING INPUT jack of the analyzer.
- (b) Turn the POWER switches of the generator and analyzer to ON.
- (c) The analyzer nixie display will indicate 25% ± 1% and the MARK lamp will illuminate to indicate marking bias.
- (d) Change the PERCENT DISTORTION switch on the generator to 20%; the analyzer nixie display will indicate 20% ±1% and the MARK lamp will illuminate to indicate marking bias.

b. *Analyzer Modes of Operation.* The analyzer is designed to provide four modes of operation; TEST MODE, DISTORTION, ERROR RATE, and PEAK MON.

(1) *Test mode.* The analyzer, when operated in conjunction with the generator, will produce a pseudo-random test pattern. This test pattern is applied to the generator through the rear panel connector and back to the analyzer for system self-test. The system self-test is performed as part of the maintenance procedures. This function is accomplished when the analyzer DISPLAY MODE switch is set to TEST MODE and when the generator MESSAGE SELECT switch is set to EXT. The BAUD RATE switches of both units must be the same and the interface cable CX-12024/GGM-15(V) must be connected. Refer paragraph 4-8 for a detailed explanation test mode operation.

(2) *Typical operation TEST MODE.* The purpose of this operating procedure is to test the analyzer error code operation. To perform the error test operation a generator (SG-860/GGM-15(V)) is required and must be connected to the analyzer through the interface cable. The initial control settings of the generator and analyzer are listed below.

Control	Position
POWER switches (analyzer and generator).	OFF
DISTORTION SELECT switch (generator).	NO DIST
MESSAGE SELECT switch (generator).	EXT
BAUD RATE switches (analyzer and generator).	120

Control	Position
MARK POLARITY switch (analyzer) .....	.....
RESET switch (analyzer).....	OFF
DISPLAY MODE (analyzer).....	TEST MODE
ERROR DEFINER thumbwheels .....	49

**NOTE**

The position of unmentioned controls will not effect error test operation.

- (a) Set the POWER switches (generator and analyzer) to ON.
- (b) Depress the RESET switch to MAN and release it. Read approximately 10 errors every 9 seconds and note an overflow indication after 98.
- (c) Set the generator DISTORTION SELECT switch to BIAS M and the PERCENT DISTORTION switches to 25.
- (d) Reduce the setting of the ERROR thumbwheel switches to the point where the nixies display a rapid count.
- (e) Read the amount of distortion on any M/S or S/M transition as indicated by the number on the thumbwheel switches.

(3) *DIST (%)*. The analyzer is used to measure distortion on data or telegraph signals when the DISPLAY MODE switch is set to DIST (%). Distortion, as measured by the analyzer is defined as the time displacement of a signal transition from its theoretically correct position. The transition is taken as the half-current point, for neutral signals and is the zero current crossover point for polar signals. The analyzer is used to measure bias, end, total, early and late peak distortion. Characteristic, fortuitous, and speed-error distortion are determined from these measurements. When making an analysis the operator should first determine the baud rate, type of signal (polar or neutral) current level, and operating mode (start-stop or synchronous). The amount of bias and end distortion is read directly on the nixie display while the MARK and SPACE lamps indicate the type. When total-early or late-peak measurements are made the MARK and SPACE lamps are inoperative. However, an early-peak reading indicates the presence of marking distortion and a late-peak

reading indicates the presence of spacing distortion. Both early and late readings indicate the presence of fortuitous distortion. To quickly determine the peak distortion without regard to early or late measurements, the DISTORTION switch is set to TOTAL. The amount of speed distortion is determined by measuring the distortion on successive transitions. The distortion measurement increases on each successive transition. A faster incoming signal will introduce marking bias and a slower incoming signal will introduce spacing bias.

(4) *Typical operation, DIST.* For the purpose of this example assume the following analyzer input signal characteristics;  $\pm 60$  volts polar at 20 ma, 150 bauds, positive mark, 1:1 reversals, 25 percent distortion (marking bias). Initial analyzer control settings are listed below.

Control	Position	Control	Position
POWER switch.....	OFF	INPUT switch.....	20P
MARK POLARITY switch.....	+	TRANSITION switch.....	ALL
RESET switch.....	OFF	DISTORTION switch.....	AVERAGE BIAS S/M
DISPLAY MODE switch.....	DIST (%)	BAUD RATE switch.....	150
CODE LEVEL switch.....	5		

**NOTE**

The position of unmentioned controls will not affect operation in this mode.

- (a) Connect the external data signal to the analyzer SERIES input jack.
- (b) Set the POWER switch to ON.
- (c) Reset the nixie display and read 25 percent average marking bias distortion  $\pm 2$  percent.
- (d) Set the TRANSITION switch to 1 and read 25 percent marking bias on the first intelligence bit  $\pm 2$  percent.
- (e) Sequentially select transitions 2, 3, 4, 5 and read the amount of bias distortion on each intelligence bit. (Odd numbered transitions are distorted, even numbered transitions do not appear on the data signal.)
- (f) Set the TRANSITION switch to ALL, the DISTORTION switch to AVERAGE END M/S, reset the nixie display and read 0 average end distortion  $\pm 2$  percent.
- (g) Set the DISTORTION switch to PEAK TOTAL, reset the nixie display and measure 25 percent total peak distortion  $\pm 2\%$ .
- (h) Set the DISTORTION switch to EARLY, reset the nixie and read 25 percent early peak distortion  $\pm 2$  percent.
- (i) Set the DISTORTION switch to LATE, reset the nixie display and read 0 percent late peak distortion-  $\pm 2$  percent.

(5) *ERROR RATE (Hits/10n).* The analyzer is used to measure error rate on a 2047 bit pseudo-random test message. The rate is displayed as errors per thousand or million bit times. The message is generated within the analyzer and is available at the rear panel connector 2A3J3. The data output is supplied at  $\pm 6$  volts at pin 8, and its return at pin 24. To measure error rate two analyzers are required, one for transmitting the message and one for receiving and analysis. For normal operation, the transmitting analyzer controls are set as follows: POWER to ON, DISPLAY MODE to TEST MODE, CODE LEVEL to SYNC, RESET to OFF and BAUD RATE to the desired operating speed. The receiving analyzer controls are set as follows: POWER to ON, DISPLAY MODE to ERROR RATE  $10^3$  or  $10^6$ , ERROR DEFINER to the maximum permissible distortion percentage. RESET to OFF and BAUD RATE to the same speed as the transmitting analyzer. The input connection is made to either the SERIES or BRIDGING input jacks on the receive analyzer front panel. The INPUT switch is set to the position that corresponds with the input signal level. The positions of the unmentioned controls will not affect operation in this mode.

The correct position of the MARK POLARITY switch is determined by setting the RESET switch to MAN and releasing to the OFF position. If the SPACE/START lamp illuminates the mark polarity is correct. If this lamp does not illuminate, set the MARK POLARITY switch to the opposite polarity and operate the RESET switch as previously described. The SPACE/START lamp will illuminate when the internal and external pseudo-random test messages are synchronized, and remain illuminated until the measurement period is completed.

When synchronization occurs the analyzer begins to count errors and will stop counting only when the period of measurement for a thousand or million bit times has elapsed. At this point the MARK-STOP lamp illuminates and the number displayed on the nixie readout indicates error rate. This number (error rate) remains displayed

until a new measurement is initiated. In order to initiate a new measurement set the RESET switch to MAN and release to the OFF position. Normally during error rate measurement the RESET switch is operated in the MAN and OFF positions to allow sufficient time for a complete measurement. Operation in the AUTO position is not recommended as the auto reset period of 3 to 5 seconds will only allow measurement for one thousand bit times above 600 baud. The nixie display is limited to a maximum error rate of 99 errors per thousand or million bit times. When this limit is reached the OVERFLOW lamp illuminates and the number of errors displayed becomes invalid. The time required to complete an error rate measurement depends on the operating speed of the analyzers. Each operating speed and the total time required to complete a thousand or million bit time measurement is listed as follows:

Operating speed in bauds	Time required to complete error rate measurement		Operating speed in bauds	Time required to complete error rate measurement	
	10 <sup>3</sup> bit times	10 <sup>6</sup> bit times		10 <sup>3</sup> bit times	10 <sup>6</sup> bit times
37.5	26-2/3 seconds	7 hrs 24 min 26-2/3 secs	300	3-1/3 seconds	55 min 33-1/3 secs
45.45	22 seconds	6 hrs 6 min 40 secs	600	1-2/3 seconds	27 min 46-2/3 secs
50	20 seconds	5 hrs 33 min	1200	5/6 seconds	13 min 53-1/3 secs
61.12	16-2/5 seconds	4 hr 33 min 20 secs	2400	5/12 seconds	6 min 66-2/3 secs
75	13-1/3 seconds	3 hrs 42 min 13-1/3 secs	43 00	6/24 seconds	3 min 23-1/3 secs
150	6-2/3 seconds	1 hr 51 min 6-2/3 secs	9600	6/43 seconds	1 min 44-1/16 secs

(6) *Typical operation ERROR RATE.* For the purpose of this procedure two analyzers are required; one for transmitting and the other for receiving. The transmitting analyzer pseudo-random output ( $\pm 6$  volts, MIL STD 188B) at 2A3J3 pins 3 (data) and 24 (ground) is connected to the bridging input of the receiving analyzer. The initial control settings are listed below:

Control	Position	Control	Position
POWER switches (transmit and receive) .....	OFF	ERROR DEFINER thumbwheels (receive) .....	49 or 00
DISPLAY MODE switch (transmit) ...	TEST MODE	BAUD RATE switch (transmit and receive) .....	600
DISPLAY MODE switch (receive).....	ERROR RATE 10 <sup>3</sup>	INPUT switch (receive) .....	HIZ
CODE LEVEL switch (transmit) .....	SYNC	MARK POLARITY (receive) .....	- (negative)

**NOTE**

The position of unmentioned controls will not affect operation in this mode.

(a) Set the POWER switches to ON and reset the nixie display.

(b) Read error rate per 1000 bit intervals on the nixie display when the measurement period is complete. Errors counted have exceeded one percent distortion.

**NOTE**

The measurement period begins when the SPACE/START lamp illuminates and ends when the MARK/FINISH lamp illuminates. The overflow lamp illuminates when the total number of errors exceeds 99.

(c) Set the DISPLAY MODE switch to 106, reset the nixies and read error rate per 1,000,000 bit intervals.

(7) *PEAK MON.* The analyzer is used as a distortion monitor when the DISPLAY MODE switch is set to PEAK MON (HITS). In this operating mode the analyzer becomes a full period peak monitor registering on the nixie display, one hit for every M/S or S/M transition that exceeds a preset distortion threshold. When peak hits are counted, distortion measurement in the analyzer are made as usual except that the distortion measurement is no longer displayed. In place of the distortion reading, the nixie display indicates the number of times the preset distortion threshold has been exceeded (hits). The distortion threshold is established by the setting of the THRESHOLD % DISTORTION thumbwheel switches. The threshold is set for the maximum permissible distortion in 1 percent increments from 00 to 49. Peak hits are detected by comparing the actual distortion present on the data signal with the distortion setting of the thumbwheels. When the actual distortion on the circuit under test is greater than the threshold setting a hit is counted, and the nixie display is updated. If, however, the distortion is equal to or less than the setting of the thumbwheels, hits are not counted and the nixie display remains unchanged. The highest number that can be displayed on the nixie readout is 99. Therefore when the number of hits counted reaches 99 the nixie display begins counting from 00 again and the OVERFLOW lamp illuminates. Peak measurements are made with RESET switch in the OFF position. If this switch is set to AUTO the peak hit measurement is interrupted every 3 to 5 seconds. To reset or destroy old peak hit readings set the RESET switch to MAN and release to the OFF position. This allows the analyzer to make a new peak hit measurement.

(8) *Typical operation PEAK MON.* For the purpose of this procedure assume the following input signal parameters: high level, neutral, 130 volts 60 milliamperes 5 level start stop code, 150 bauds. 30 percent distortion negative mark. Initial analyzer control settings are listed below.

Control	Position	Control	Position
POWER switch.....	OFF	ERROR DEFINER thumbwheels .....	25
MARK POLARITY switch.....	----	CODE LEVEL switch.....	5
RESET switch .....	OFF	INPUT switch.....	60N
DISPLAY MODE switch .....	PEAK MON	BAUD RATE switch.....	150

**NOTE**

The position of unmentioned controls will not affect operation in this mode.

- (a) Connect the external data signal to the analyzer SERIES INPUT jack.
- (b) Set POWER switch to ON and reset the nixie display.
- (c) Read hits on the nixie display and note that the nixies display a rapid count. The rapid count indicates that distortion on the input data signal exceeds the threshold setting of 25 percent. The overflow lamp will illuminate when the total hit counted exceeds 99.

(d) Increase the setting of thumbwheels in one percent increments until the nixies no longer display a rapid count. Note that the thumbwheel setting is approximately 30 ±2 percent.

(e) Reset the nixie display and note that with the threshold set at 30 percent hits are seldom counted.

c. *Distortion Measurements.*

(1) *AVERAGE BIAS S/M.* Bias distortion, as measured by the analyzer is the average displacement of the S/M transitions from the correct positions. Marking bias is the result of a lengthened mark interval (transition occurs early, while spacing bias is the result of lengthened space interval; transition occurs late). Bias distortion is measured when the DISTORTION switch is set to AVERAGE, BIAS, S/M. The amount of bias is displayed on the nixie readout with marking or spacing bias indicated when the MARK or SPACE lamp illuminates. A signal containing zero distortion and operating at the same speed as the analyzer will cause the nixie display to read zero and the MARK and SPACE lamps to blink alternately.

(2) *AVERAGE END M/S.* End distortion as measured by the analyzer is the average displacement of the M/S transitions relative to the first M/S transition (start pulse). The distortion is called marking end if the mark interval of the first intelligence bit is lengthened (transition occurs late) and spacing end if the resulting space interval is lengthened (transition occurs early). AVERAGE, END M/S. The amount of end distortion is displayed on the nixie readout with marking or spacing end indicated when the MARK or SPACE lamp illuminates.

(3) *PEAK TOTAL.* The total peak distortion as measured by the analyzer is the highest amount of distortion of any type occurring on the signal during the period of measurement. The distortion may occur on M/S (mark-to-space) or S/M (space-to-mark) transitions, either early or late. A single transition is sufficient to give the peak distortion with full accuracy. The reading will be maintained on the nixie display until changed by a higher reading or reset to zero. The total peak measurement is made when the DISTORTION switch is set to PEAK TOTAL. The RESET switch is used to reset the nixie display in order to obtain a new reading which is lower than that maintained on the nixie display. Since the total peak distortion is measured on both M/S and S/M transitions simultaneously and the definition of marking and spacing distortion changes with the type of transition the MARK and SPACE lamps are made inoperative.

(4) *PEAK EARLY, LATE.* When the DISTORTION switch is set to PEAK EARLY the analyzer measures the maximum distortion of both M/S and S/M transitions occurring earlier than the correct time. When the DISTORTION switch is set to PEAK LATE the analyzer measures the maximum distortion of both M/S and S/M transitions occurring later than the correct time. The ability to display separately early and late peak distortion, enables the operator to measure the maximum amount of random fortuitous distortion prevalent when transmitting teletype over radio circuits.

d. *Transition Selection.* The analyzer will measure distortion for any one or all transition times in a start-stop character. With the TRANSITION switch set to ALL and the DISTORTION switch set to BIAS, S/M the distortion is measured on all S/M transitions in the character. With the DISTORTION switch set to END, M/S the distortion is measured on all M/S transitions except for the start bit. When the DISTORTION switch is set

to TOTAL, distortion is measured on all transitions within the character, both M/S and S/M. When the switch is set to EARLY or LATE, distortion is measured on all transitions (M/S or S/M) occurring early or late respectively. Total, early, or late peak measurements will be retained on the front panel nixie display until higher distortion is measured or until the display is reset, either automatically or manually. The TRANSITION switch can be used to select any particular transition interval within the start-stop character for measurement.

e. *Code Levels.* The analyzer is designed to analyze all start-stop signals with code levels from 5 to 8. The most common code is the 5 level Baudot code used in telegraph communications. A teletypesetter 6 level code is also in general use. Start-Stop data transmission signals generally employ an 8 level code. It is important to know the type of signal and the code level of the signal when operating the analyzer. Erratic operation of the analyzer may result from improper setting of the CODE LEVEL switch.

f. *Synchronous Operation.* The analyzer has a built-in digital synchronizer designed to make its timing circuits synchronize and follow the timing of an incoming signal. For proper functioning of the synchronizer, the timing of the input signal must be within 0.1% of the analyzer timing. Only bias distortion measurements are possible since there is no end distortion in a synchronous signal. To make the measurement, set the CODE LEVEL switch on the analyzer to SYNC; the TRANSITION SELECT switch should be in the ALL position. The reading on the nixie display will indicate the bias distortion contained in the synchronous signal. Peak distortion measurements cannot be made until the analyzer has synchronized with the incoming signal. Synchronization can be checked by measuring any cumulative bias distortion as indicated in g below. Synchronous signals may also be analyzed on a start-stop basis using any of the positions of the CODE LEVEL switch. In this method, the analyzer will select a M/S transition as a reference and measure the remaining transition times relative to it for an equivalent character time as determined by the setting of the CODE LEVELS switch. It will then stop and wait for the next M/S transition before starting another measuring cycle. This method will produce satisfactory results except when there is a significant amount of fortuitous distortion in the signal.

g. *Speed Error Measurement.* Differences between the operating speed of the analyzer as selected by the BAUD RATE switch and the incoming signal will introduce bias or end distortion. A faster incoming signal introduces marking bias or spacing end distortion while a slower incoming signal introduces spacing bias or marking end distortion. On a random signal pattern, the distortion measurement on each successive transition within a character will increase when there is a difference in speeds. By using the TRANSITION switch, a measurement can be made on each transition of the incoming signal to determine the distortion increase from the first transition to the last. The amount of speed error in percent is one-fifth of the increase in distortion reading from transition one to transition six. *For example, a five-percent increase in marking bias distortion from the first to the sixth transition would indicate the incoming signal is one percent faster than the operating speed of the analyzer.*

h. *Analyzer Strapping Options.* The analyzer is provided with a strapping option for the selection of a spare operating speed. When the spare speed option is exercised the spare oscillator on assembly 2A2A7 produces an output at the crystal frequency (2A2A7Y3). This output is applied to the time base circuits, which are also located on this assembly. Outputs from the time base circuits are available at 9 different frequencies. Any one of these 9 frequencies may be selected by the spare speed strap to produce an output at 200 times the desired baud rate.

**3-9. Oscilloscope Operating Procedures**

The procedures outlined in this paragraph must be read before attempting to operate the oscilloscope. As an aid to the operation a typical operating procedure follows the description of each operating mode.

a. *Oscilloscope. OS-206/GGM-15(V) Preliminary Starting Procedure.*

- (1) Check power and interface cable connections (fig. 2-9).
- (2) Connect the oscilloscope to the correct ac power source (para 2-6).
- (3) For a preliminary test of the oscilloscope set the controls as follows:

Control	Position	Control	Position
POWER switch	OFF	Z MARKERS switch	OFF
DISPLAY RELEASE RATE switch	NORMAL	VERT VOLTS (MA)/CM	50
TRIGGER & SWEEP SELECT switch.	AUTO	TIME MILLISEC	0.05 to 0.5

(4) Set the POWER switch to ON and adjust the FOCUS, ASTIG, INTENSITY, VERT and HORIZONTAL POSITION for the best display.

b. *Oscilloscope Modes of Operation.* The oscilloscope is designed to operate in conjunction with the analyzer in any one of three operating modes, AUTO, FREE RUN or INT.

(1) *AUTO.* With the TRIGGER & SWEEP SELECT switch set to AUTO the horizontal sweep is generated within the oscilloscope. The method of generating the sweep is by means of a digital to analogue counter converter. The sweep is triggered and reset by the analyzer and automatically adjusted to the analyzer operating speed and code level. The input data signal to the analyzer will be displayed on the CRT. To view single transitions the analyzer TRANSITION switch is set to select any transition, 1 through 9. The transition as selected on the analyzer is the only transition displayed on the oscilloscope.

(2) *Typical Operation, AUTO.* The purpose of this operating procedure is to display on the oscilloscope CRT, the data input to the analyzer automatically triggered, reset and adjusted to the analyzer operating speed. The analyzer is assumed to be measuring distortion on ±6 volt polar 5 level start-stop input during the procedure. Initial control settings are listed below.

Control	Position
PWR switch.....	OFF
DISPLAY RELEASE RATE switch....	NORMAL
TRIGGER & SWEEP SELECT switch.....	AUTO
Z MARKERS switch.....	OFF

Control	Position
VERTICAL VOLTS (MA)/CM switch.....	5
TIME MILLISEC switch .....	The TIME MILLISEC switch is inoperative in the AUTO mode.

(a) Set the PWR switch to ON.

(b) Adjust the FOCUS, ASTIG, INTENSITY CRT, VERT POS and HORIZONTAL POSITION controls for the best display.

(c) The oscilloscope displays a 5 level character, automatically triggered and adjusted to the analyzer operating speed.

(d) Set the analyzer TRANSITION switch to select any single transition displayed for measurement.

(e) The oscilloscope displays only the transition selected by the analyzer.

(f) Set the Z MARKERS switch to ON and note that the brightness is intensified on the CRT for each theoretically correct positions of an undistorted transition in the data signal.

(3) *FREE RUN.* In the FREE RUN operating mode the oscilloscope sweep is generated internally and triggered by the analyzer. The free running sweep is unsynchronized and used to view crossover patterns. (Set the DISPLAY RELEASE RATE switch to MAN when viewing crossover patterns.) Horizontal sweep rate is variable from 0.05 to 500 milliseconds as controlled by the TIME MILLISEC switch and its corresponding VARIABLE control to adjust the horizontal size of the displayed waveform.

(4) *Typical Operation, FREE RUN.* For the purpose of this procedure assume that the analyzer is measuring distortion on a 180-volt, 60-ma neutral signal at 150 baud. Initial control settings are listed below.

Control	Position
PWR switch.....	OFF
DISPLAY RELEASE RATE switch....	NORMAL
TRIGGER & SWEEP SELECT switch.....	FREE RUN

Control	Position
Z MARKERS switch .....	OFF
VERTICAL VOLTS (MA)/CM switch.....	50
TIME MILLISEC switch .....	6-50

(a) Set the PWR switch to ON.

(b) Adjust the FOCUS, ASTIG, INTENSITY CRT, VERT POS and HORIZONTAL POSITION controls for the best display.

(c) The oscilloscope displays a free running data pattern at 0 to +130 volts with the horizontal sweep controlled by the TIME MILLISEC switch and VARIABLE adjustment potentiometer.

(d) Set the DISPLAY RELEASE RATE switch to VARIABLE and note that the display release rate is adjustable from 0.5 to 2 seconds as controlled by the DISPLAY RELEASE RATE potentiometer.

(5) *INT, (EXT TRIG).* When the oscilloscope is operated in the INT mode the horizontal sweep is

triggered and synchronized by the analyzer. The synchronizing signal is supplied one-half bit into the start pulse when the analyzer TRANSITION switch is set to ALL or 1. The point of synchronization can be varied by the analyzer TRANSITION switch. When the switch is advanced to 2, the synchronizing signal occurs half-way into first bit time interval, rather than the start bit. As the TRANSITION switch on the analyzer is advanced to the succeeding positions, the synchronizing signal from the analyzer to the oscilloscope advances halfway into the next bit time.

**NOTE**

The last or highest numbered effective setting of the TRANSITION switch is one position higher than the position of the CODE LEVEL switch.

(6) *Typical Operation, INT (EXT TRIG).* For the purpose of this procedure assume that the analyzer is measuring distortion on a ±60-volt 20-ma input at 150 bauds. The initial control settings are listed below.

Control	Position	Control	Position
PWR .....	OFF	Z MARKERS.....	OFF
DISPLAY RELEASE RATE switch.....	NORMAL	VERTICAL VOLTS (MA)/CM switch .....	20
TRIGGER & SWEEP SELECT switch. ...	INT (EXT TRIG)	TIME MILLISEC switch .....	5.0 to 0.5

(a) Set the PWR switch to ON.

(b) Adjust the FOCUS, ASTIG, INTENSITY CRT, VERT POS and HORIZONTAL POSITION controls for the best display.

(c) The oscilloscope displays the data signal measured by the analyzer at ±60 volts. Note that the horizontal sweep is synchronized and that sweep range is adjusted by the TIME MILLISEC controls.

(d) Set the DISPLAY RELEASE RATE switch to MAN and note that the horizontal sweep is disabled.

(e) Press the SINGLE release toggle switch and note that the horizontal sweep is released.

c. *Vertical Input Control.* For the purpose of calibrating the vertical input to the oscilloscope, the analyzer is provided with a VCAL position for the INPUT switch. When the analyzer INPUT switch is set to this position a calibrated ±10-volt 60-hz signal is applied to the oscilloscope. The signal viewed on the CRT is adjusted for the proper deflection as designated by the position of the VERTICAL VOLTS (MA)/CM control. The VERTICAL VOLTS (MA)/CM controls are used to measure input signal current in the 2 through 50 positions and input signal voltage levels in the 2 through 200 positions.

d. *Display Release Operation.* The display of each triggered sweep may be controlled by the DISPLAY RELEASE RATE switch when operating the TRIGGER & SWEEP SELECT switch in the INT positions, to effectively blank an integral number of characters. In the NORMAL position of the DISPLAY RELEASE RATE switch, the sweep triggers once per character, as determined by the analyzer. Thus every character is displayed. In the VARIABLE position, the time between sweeps is controlled by the variable DISPLAY RELEASE RATE control. The sweep although still triggered by the analyzer is not generated for a period of 1/2 to 2 seconds as determined by the setting of the variable DISPLAY RELEASE RATE control. The setting of this control therefore limits character-viewing rate. This feature is especially useful when the character rate is high and the operator is viewing random characters or traffic. Waveshapes would otherwise be indistinguishable. Only full characters will be viewed since the synchronizing signal from the analyzer occurs at the beginning of the character one-half bit after the start pulse. In the MAN position of the DISPLAY RELEASE RATE switch the sweep is effectively blanked until the SINGLE release toggle switch is pressed and released. The next sweep to be triggered will then be displayed. The sweep is still synchronized to begin at the same point in a character that would occur if the DISPLAY RELEASE RATE switch were in the NORMAL position.

**3-10. Stopping and Shutdown Procedures**

Shutdown each major component of the test set as follows:

- a. Disconnect all external equipment connections.
- b. Set all POWER switches to OFF.
- c. Return all front panel operating controls to the starting positions listed in paragraph 3-7.

**Section III. OPERATION UNDER UNUSUAL CONDITIONS**

**3-11. General**

The operation of the test set may be difficult in regions where extreme cold, heat humidity, or other moisture and sand conditions prevail. Paragraphs 3-12, 3-13, and 3-14 provide procedures that minimize the effects of these unusual climatic conditions.



**3-12. Operation in Arctic Climates**

Subzero temperatures and climatic conditions associated with cold weather affect the efficient operation of the equipment. Instructions and precautions for operation under such adverse conditions are-

- a. Keep the equipment warm and dry.
- b. When equipment that has been exposed to the cold is brought into a warm room, moisture will gather on the equipment; this may cause a change in operating characteristics. When the equipment reaches room temperature, dry it thoroughly. Wipe the exterior surfaces with a soft cloth. Dry the internal surfaces using a fan or warm air blower. Do not wipe circuit boards.

**3-13. Operation in Tropical Climates**

When operated in tropical climates, installation may be made in tents, huts, or, when necessary, in underground dugouts. When equipment is installed below ground and when it is set up in swampy areas, moisture conditions are more acute than normal in the tropics. Ventilation is usually very poor, and the high relative humidity causes condensation on the equipment whenever the temperature of the equipment becomes lower than that of the surrounding air. To minimize this condition, provide, as good ventilation as possible. Dry equipment thoroughly before operating it. Do not handle moist circuit boards. Open front hinged panels for better air circulation.

**3-14. Operation in Desert Climates**

- a. The main problem that arises with equipment operation in desert areas is the large amount of sand, dust, or dirt that enters the equipment.
- b. Be careful to keep the equipment as free from dust as possible. Make frequent preventive maintenance checks (ch. 4). This equipment does not need lubrication and should be kept free from oil and grease. Excessive amounts of dust, sand, or dirt that come into contact with oil and grease result in grit, which will damage the equipment.

**CAUTION**

When operating the equipment at temperatures over 130° F, open all hinged panel doors slightly to provide additional ventilation of heat from compartments.

**CHAPTER 4  
MAINTENANCE**

**4-1. Scope of Maintenance**

The maintenance duties assigned to the operator and organizational maintenance personnel are listed below, together with a reference to paragraphs covering the specific maintenance function. Replacement of parts and circuit adjustments are authorized only at GS or depot maintenance categories. The operator and organizational maintenance personnel shall perform only preventive maintenance duties and replacements within their scope of ability and tool allowance.

- a. Daily preventive maintenance checks and services (para 4-5).
- b. Weekly preventive maintenance checks and services (para 4-6).
- c. Quarterly preventive maintenance checks and services (para 4-7).
- d. Cleaning, painting, and preservation (para 4-9).
- e. Troubleshooting (para 4-10).

**4-2. Tools, Materials and Test Equipment Required**

The tools, materials, and test equipment required for organizational maintenance are listed in appendix B.

**4-3. Operator's Preventive Maintenance**

Preventive maintenance is the systematic care, servicing, and inspection of equipment to prevent the occurrence of trouble, to reduce downtime, and to assure that the equipment is serviceable.

a. *Systematic Care.* The procedures given in paragraphs 4-4 through 4-9 cover routine system systematic care and cleaning essential to proper upkeep and operation of the equipment.

b. *Preventive Maintenance Checks and Services.* The preventive maintenance checks and services charts (paras 4-5, 4-6, and 4-7) outline functions to be performed at specific intervals. These checks and services are to maintain Army electronic equipment in good serviceable and operating condition. To assist operators in maintaining combat serviceability, the charts indicate what to check, how to check, and what the normal conditions are. *The References* column lists the illustration, paragraph, or manual that contains detailed repair or replacement procedures. If the defect cannot be remedied by the operator, higher category of maintenance or repair is required. Records and reports of these services must be made in accordance with the requirements set forth in TM 38-750.

**4-4. Preventive Maintenance Checks and Service Periods**

Preventive maintenance checks and services of the test set are required daily, weekly, and quarterly. Paragraphs 4-5, 4-6, and 4-7 list daily, weekly, and quarterly preventive maintenance checks and services. Daily checks and services must be performed-

- a. When the equipment is initially installed.
- b. Before connection for testing or use.
- c. At least once each week if equipment is maintained in standby condition.

**4-5. Daily Preventive Maintenance Checks and Services**

Sequence No.	Item	Procedure	References
1	Exterior surfaces .....	Clean the front panels and display faces.....	
2	Cables and connectors .....	Check interface, power cables and connectors for damage and proper installation.	Paragraph 2-7b, figure 2-9.

Sequence No.	Item	Procedure	References
3	Knobs dials and switches	Check all front panel controls for smooth mechanical operation.	Paragraph 2-10. Paragraph 2-4.
4	Fuses and crystals	Open hinged front panels and check fuses and crystals for correct value and proper location.	
5	Plug-in assemblies	Check each plug-in assembly for proper location and secure engagement with its connector.	
6	Mounting	Check all mounting hardware for tightness and secure fit.	

**4-6. Weekly Preventive Maintenance Checks and Services**

Sequence No.	Item	Procedure	References
1	Daily preventive maintenance checks and services.....	Perform the daily preventive maintenance checks and services.	Paragraph 4-5.
2	Generator indicator lamps .....	<ul style="list-style-type: none"> <li>a. Set the generator POWER switch to ON and note that the POWER lamp illuminates</li> <li>b. Set the generator MESSAGE SELECT switch to M and note the SIGNAL lamp illuminates.</li> <li>c. Set the BAUD RATE switch to SPARE (spare speed option must not be exercised) and note that the ALARM lamp illuminates, within 2 to 8 seconds.</li> </ul>	Paragraphs 3-7a .and 3-8a.
3	Analyzer indicator lamps .....	<ul style="list-style-type: none"> <li>a. Perform the preliminary starting procedures for the generator and analyzer.</li> <li>b. Set the analyzer MARK POLARITY switch to + and the INPUT switch to HIZ.</li> <li>c. Connect a patch cord from the DATA ±6/12v output jack of the generator to the BRIDGING input jack of the analyzer.</li> <li>d. Set the generator and analyzer POWER switches to ON and note that the analyzer POWER lamp, SIGNAL lamp, and nixie display illuminates.</li> <li>e. Set the generator DISTORTION SELECT switch to BIAS, SW and the PERCENT DISTORTION switch to 25. Note that the analyzer MARK and SPACE lamps illuminate.</li> <li>f. Set the DISPLAY MODE switch to PEAK MON, and note that the OVERFLOW lamp illuminates after a count of 99 when the display is reset.</li> <li>g. Set the analyzer BAUD RATE switch to SPARE (spare speed option must not be exercised) and note that the CLOCK lamp illuminates within 2 to 8 seconds.</li> </ul>	
4	Oscilloscope indicator lamp. ....	<ul style="list-style-type: none"> <li>a. Perform the preliminary starting procedure for the oscilloscope.</li> <li>b. Set the oscilloscope POWER switch to ON and note that the POWER lamp illuminates.</li> </ul>	
5	Generator speed .....	Rotate the generator BAUD RATE switch slowly through all 14 positions. Note that the OSC FAILURE lamp illuminates, only in the SPARE and EXT. positions when these options are not exercised. (Pause for 8 seconds at each position of the BAUD RATE switch.)	
6	Analyzer speeds.....	Rotate the analyzer BAUD RATE switch through all 14 positions. Note that the CLOCK lamp illuminates only in the SPARE and EXT. positions when three options are not exercised. (Pause for 8 seconds at each position of the BAUD RATE switch.)	
		Note. This completes the weekly preventive maintenance checks and services. Set all POWER switches to OFF, if not proceeding with the quarterly preventive maintenance checks and services.	

4-7. Quarterly Preventive Maintenance Checks and Services

Sequence No.	Item	Procedure	References
1	Preservation.....	Check all surfaces for evidence of fungus. Remove rust and corrosion and spot-paint bare spots.	
2	Publications.....	See that all publications are complete, serviceable, and current.	DA-Pam 810-4
3	Modifications.....	Check DA Pam 810-7 to determine if new applicable MWO's have been published. All URGENT MWO's must be applied immediately.	TM 88750 and
4	Spare parts.....	Check all spare parts (operator and organizational) for general condition and method of storage. There shall be no overstock, and all shortages must be on valid requisitions.	DA Pam 810-7.
5	Daily preventive maintenance checks and services	Perform the daily preventive maintenance checks and services.	App. C
6	Weekly preventive maintenance checks and services.	Perform the daily preventive maintenance checks and services.	Paragraph 4-5
7	Test set operational distortion check.	a. Set the generator and analyzer BAUD RATE switches to 1200.	Paragraph 4-6
		b. Set the analyzer DISPLAY MODE switch to DIST. And read 25% switching bias $\pm 2$ counts.	
		c. Set the oscilloscope VERTICAL VOLTS (MA)/CM switch to 10.	
		d. Set all the generator SELECTED CHARACTER BIT switches to space except for 1 and 2. Note that the distorted 5 level character "A" is displayed on the oscilloscope.	
		e. Set the generator DISTORTION SELECT switch to BIAS, S and note that-	Figure 4-1
		(1) Nixie display indicates $25 \pm 2$ counts.	
		(2) Analyzer space/start lamp illuminates.	
		(3) Oscilloscope displays spacing bias.	
		f. Set the DISTORTION SELECT switch to BIAS, M and note that-	Figure 4-1
		(1) Nixie display indicates $25 \pm 2$ counts.	
		(2) MARK/FINISH lamp is illuminated.	
		(3) Oscilloscope displays marking bias.	
		g. Set DISTORTION SELECT switch to END S/S, M, and note that-	Figure 4-1
		(1) Nixie display indicates $00 \pm 2$ counts.	
		(2) Oscilloscope displays marking end distortion.	
		h. Set DISTORTION switch to AVG END M/S, and note that-	Figure 4-1
		(1) Nixie display indicates $25 \pm 2$ counts.	
		(2) MARK/FINISH lamp is illuminated.	
		(3) Oscilloscope displays marking end distortion.	
		i. Set DISTORTION SELECT switch to END S/S, S and note that-	Figure 4-1
		(1) Nixie display indicates $25 \pm 2$ counts.	
		(2) SPACE/START lamp is illuminated.	
		(3) Oscilloscope displays spacing end distortion.	
		j. Set DISTORTION switch to PEAK TOTAL, and note that	Figure 4-1
		(1) Nixie display indicates $25 \pm 2$ count	
		(2) Oscilloscope displays spacing end distortion.	
		k. Set DISTORTION switch to PEAK EARLY, and note that-	Figure 4-1
		(1) Nixie display indicates $25 \pm 2$ count.	
		(2) Oscilloscope displays spacing end distortion.	
		l. Set DISTORTION switch to PEAK LATE, reset the nixie display and note that-	Figure 4-1
		(1) Nixie display indicates $00 \pm 2$ counts.	
		(2) Oscilloscope displays spacing end distortion.	
		m. Set all POWER switches to OFF.	

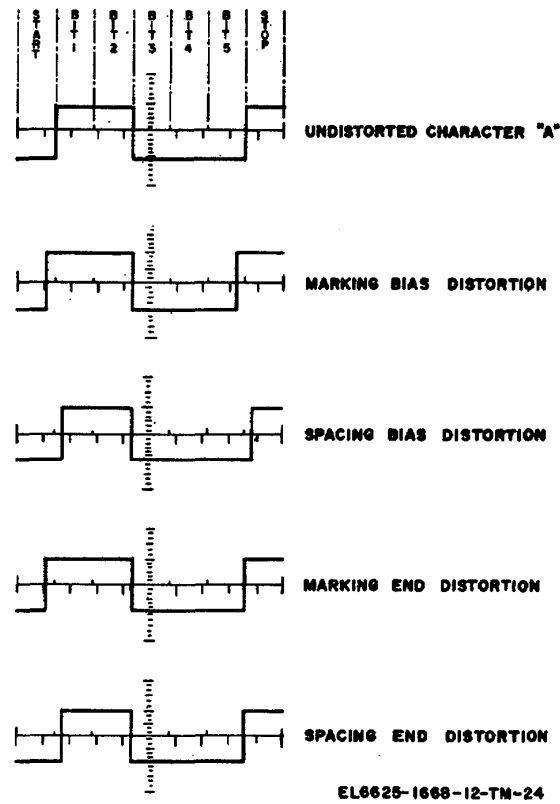

Figure 4-1. Distortion oscilloscope display.

**4-8. Analyzer Self-Test (Error Test Mode)**

The analyzer is provided with an error test operating mode which is used to self-test the system error code operation. To perform the error test, the analyzer DISPLAY MODE switch is set to TEST MODE and the ERROR DEFINER thumbwheels are set to 49. The MARK POLARITY switch is set to the position which causes the START lamp to illuminate. The generator MESSAGE SELECT switch must be set to EXT. and the DISTORTION SELECT switch to NO DIST. An operating speed of 1200 bauds is recommended for both generator and analyzer to reduce the time required for error rate measurement.

**NOTE**

The position of unmentioned controls will not effect error test operation.

When ac power is applied and the correct position of the MARK POLARITY switch is established the analyzer will count approximately 10 errors every 9 seconds and indicate an overflow at 99. The overflow indication denotes that the maximum reading of the nixie display has been reached. To further define errors, set the generator DISTORTION SELECT switch to BIAS M and the PERCENT DISTORTION switches to 25. Reduce the setting of the ERROR DEFINER thumbwheel switches to the point where the nixies display a rapid count. The setting of the thumbwheel switches, at this point, indicates the amount of distortion on any M/S or S/M transition.

**4-9. Cleaning, Painting, and Preservation**

Inspect the exterior surfaces of the AN/GGM-15(V). The exterior surfaces should be clean and free of dust, dirt, grease, and fungus.

- a. Remove dust with a clean, soft cloth.

**WARNING**

Prolonged breathing of cleaning compound is dangerous; provide adequate ventilation. Cleaning compound is flammable; do not use near an open flame.

- b. Remove grease, fungus, and ground-in dirt from exterior cabinet surfaces; use a cloth dampened (not wet) with cleaning compound.
- c. Remove dust or dirt from plugs and jacks.

**CAUTION**

Do not press on the meter or indicator faces (glass or plastic) when cleaning; the faces may become damaged. Do not clean plastic with alcohol or other solvents; the plastic may become clouded, or dissolved. Clean front panels carefully; or markings may be erased.

**4-10. Troubleshooting Procedure**

Troubleshooting of this equipment is based on the preventive maintenance checks and services. To troubleshoot the equipment perform each sequence in paragraphs 4-6 and 4-7. If an indication does not appear as described check the sequence number against the item number in paragraph 4-11 and perform the corrective measures listed. If the corrective measures listed do not correct the trouble, higher level of maintenance is required.

**4-11. Troubleshooting Chart**

Item No	Trouble symptom	probable trouble	Checks and corrective measures
<i>Paragraph 4-6:</i>			
2a .....	POWER lamp does not illuminate.	Defective lamp 1A1DS2 or fuses 1A2A12F1, 1A2A12F2	Check lamp and fuse continuity, replace if necessary.
2b .....	SIGNAL lamp does not illuminate.	Incorrect control setting, defective lamp 1A1DS3, fuses 1A2A12F3, 1A2A12F4 or patch cord.	Check lamp fuse and patch cord continuity. Replace if necessary.
2c .....	ALARM lamp does not illuminate	Defective lamp 1A1PS1 or plug-in assembly 1A2A4	Check lamp continuity and substitute a known good assembly 1A2A4. Replace if necessary.
3d .....	POWER lamp does not illuminate.	Defective lamp 2A1DS2 or fuses 2A2A9F1, 2A2A9F2	Check lamp and fuse continuity, replace if necessary.
3e .....	M and S lamps do not illuminate.	Defective lamps 2A1DS5, 2A1DS6 or plug in assembly 2A2A3.	Check lamp continuity, and substitute a known good assembly 2A2A3. Replace if necessary.
3f .....	OVERFLOW lamp does not illuminate.	Defective lamp 2A1DS3 or plug-in assembly 2A2A5.	Check lamp continuity and substitute a known good assembly 2A2A5. Replace if necessary.
3g .....	CLOCK lamp does not illuminate.	Defective lamp 2A1DS6 or plug-in assembly 2A2A.	Check lamp continuity and substitute a known good assembly 2A2A.
4b .....	POWER lamp does not illuminate.	Defective lamp 3A1DS5 or fuses 3A3F1, 3A3F2.	Check lamp and fuse continuity. Replace if necessary.
<i>Paragraph 4-7:</i>			
7b .....	Analyzer does read 25% switching bias.	Incorrect control settings or defective plug-in assembly 2A2A3.	Check control settings (paras 4-6, and 4-7). Check oscilloscope for display of character "A". If character is displayed, substitute assembly 2A2A3 and replace if necessary. If character is not displayed proceed to item 7d.
7d .....	Oscilloscope does not display the character "A".	Incorrect control settings. Defective interface cable or generator plug-in assembly 1A2A3.	Check control settings (paras 4-6 and 4-7). Check continuity and correct installation of interface cable. Substitute a known good assembly 1A2A3. Replace if necessary.
7e .....	Analyzer does not read 25% spacing bias.	Incorrect control settings or defective plug-in assemblies 1A2A4, 2A2A3.	Check control settings, (paras 4-6 and 4-7). Substitute known good plug-in assemblies for 1A2A4 and 2A2A3.

Item No	Trouble symptom	probable trouble	Checks and corrective measures
7f.....	Analyzer does not read 25% marking bias.	Refer to item 7e above.	
7h.....	Analyzer does not read 25% marking end.	Refer to item 7e.	
7i.....	Analyzer does not read 25% spacing end.	Refer to item 7e.	
7j.....	Analyzer does not read total peak distortion.	Refer to item 7e.	
7k.....	Analyzer does not read early peak distortion.	Refer to item 7e.	

## CHAPTER 5 SHIPMENT, LIMITED STORAGE, AND DEMOLITION TO PREVENT ENEMY USE

### Section I. SHIPMENT AND LIMITED STORAGE

#### 5-1. Disassembly of Equipment

For repackaging, the major components of the test set must be disassembled as follows:

- a. *AN/GGM-15(V)1* (fig. 1-1).
  - (1) Disconnect the power cords from external power source.
  - (2) Remove all test cords or cables from the front panel jacks and connectors.
  - (3) Remove all interconnecting cables and store them with the test cords and cables.
  - (4) Remove the rack-mounting screws from the top unit and then remove the unit from the rack.
  - (5) Repeat the procedure given in (4) above for the other units, working from the top downward.
- b. *AN/GGM-15 (V)2* (fig. 1-2).
  - (1) Perform the procedures given in a(1) through (5) above.
  - (2) Lift the CY-6672/GGM-15 (V) from the V-434/GGM-15 (V), and place it on a packaging platform, clean surface, or floor.
  - (3) Dismantle the removable shelves from the V-434/GGM-15 (V) and fold the frame.

#### 5-2. Repackaging for Shipment or Limited Storage

Repackaging of the AN/GGM-15 (V) is illustrated in figures 2-1, 2-2, and 2-3 and is performed as follows.

- a. *Packaging Operating Units.*
  - (1) Disconnect all cables from the front and rear panels.
  - (2) Remove the rack or cabinet mounting screws.
  - (3) Place the unit in box.
  - (4) Place cables and technical manual as shown in figure 2-1 The CX-12024/GGM-15 (V) and technical manual are packed with the TS-2862/GGM-15 (V).
  - (5) Close the box and seal with waterproof tape.
  - (6) Repack the box into wooden crate in accordance with the original packing.
- b. *Packaging CY-6672/GGM-15 (V).*
  - (1) Remove all units from the CY-6672/GGM-15 (V).
  - (2) Wrap the cushioning material around the CY-6672/GGM-15 (V).
  - (3) Place the wrapped CY-6672/GGM-15 (V) in the carton as shown in figure 2-2.
  - (4) Seal the box with waterproof tape.
- c. *Packaging V-434/GGM-15 (V).*
  - (1) Remove the top support shelf.
  - (2) Remove the bottom shelf.
  - (3) Remove the caster wheels.
  - (4) Package each caster wheel in a protective material.
  - (5) Collapse the V-434/GGM-15 (V).
  - (6) Place the collapsed V-434/GGM-15 (V) in a carton as shown in figure 2-3.
  - (7) Package the top shelf and bottom shelf together, back to back, with the separator cushion in between.
  - (8) Place the packaged shelves inside the collapsed V-434/GGM-15 (V).
  - (9) Close the carton and seal it with waterproof tape.

### Section II. DEMOLITION OF MATERIAL TO PREVENT ENEMY USE

#### 5-3. Authority for Demolition

Demolition of the equipment will be accomplished only upon the order of the commander. The destruction procedures outlined in paragraph 5-4 will be used to prevent enemy use of the equipment. Destruction will be accomplished by the operator or unit repairman receiving such orders.

#### 5-4. Methods of Destruction

Use any of the following methods to destroy the equipment:

- a. *Smash.* Smash the controls, printed circuit boards, switches, lamps, and cathode ray tube.
- b. *Cut.* Cut the connecting and test cords and cables.
- c. *Burn.* Burn cords, cables, and technical manuals.



*d. Bend.* Bend panel, case, and cabinet. Pull out printed circuit boards and bend or break.

*e. Explode.* If time is urgent, use explosives, firearms, grenades, or TNT, Practice personnel safety when explosives are used.

*f. Dispose.* If time permits, remove printed circuit boards and any removeable part; bury or scatter destroyed parts in slit trenches, foxholes, or throw them into streams.

**APPENDIX A  
REFERENCES**

---

DA Pam 310-4	Index of Technical Manuals, Technical Bulletins, Supply Manuals (Types 7, 8, and 9), Supply Bulletins, and Lubrication Orders.
DA Pam 310-7	U. S. Army Equipment Index of Modification Work Orders.
MIL-STD-188B	Military Communications System Technical Standards.
SB 38-100	Preservation, Packaging, Packing, Marking, and Materials, Supplies, and Equipment used by the Army.
TB 746-10	Field instructions for Painting and Preserving Electronics Command Equipment.
TM 11-6130-242-15	Organizational, DS, GS, and Depot Maintenance Manual, Including Repair Parts and Special Tool Lists: Power Supply PP-941/G.
TM 38-750	The Army Maintenance Management System (TAMMS).
TM 740-90-1	Administrative Storage of Equipment.

## APPENDIX B MAINTENANCE ALLOCATION

---

### Section I. INTRODUCTION

#### B-1. General

This appendix provides a summary of the maintenance operations covered in the equipment literature for Test Sets AN/GGM-15(V)f and AN/GGM-15(V)2. It authorizes categories of maintenance for specific maintenance functions on repairable items and components, and the tools and equipment required to perform each function. This appendix may be used as an aid in planning maintenance operations.

#### B-2. Maintenance Functions

Maintenance functions will be limited to and defined as follows:

*a. Inspect.* To determine serviceability of an item by comparing its physical, mechanical, and electrical characteristics with established standards.

*b. Test.* To verify serviceability and to detect incipient electrical or mechanical failure by use of special equipment such as gages, meters, etc. This is accomplished with external test equipment and does not include operation of the equipment and operator type tests using internal meters or indicating devices.

*c. Service.* To clean, to preserve, to charge, and to add fuel, lubricants, cooling agents and air. If it is desired that elements such as painting and lubricating be defined separately, they may be so listed.

*d. Adjust.* To rectify to the extent necessary to bring into proper operating range.

*e. Align.* To adjust two or more components or assemblies of an electrical or mechanical system so that their functions are properly synchronized. This does not include setting the frequency control knob of radio receivers or transmitters to the desired frequency.

*f. Calibrate.* To determine the corrections to be made in the readings of instruments or test equipment used in precise measurement. Consists of the comparison of two instruments, one of which is a certified standard of known accuracy, to detect and adjust any discrepancy in the accuracy of the instrument being compared with the certified standard.

*g. Install.* To set up for use in an operational environment such as an encampment, site, or vehicle.

*h. Replace.* To replace unserviceable items with serviceable like items.

*i. Repair.* To restore an item to serviceable condition through correction of a specific failure or unserviceable condition. This function includes, but is not limited to welding, grinding, riveting, straightening, and replacement of parts other than the trial and error replacement of running spare type items such as fuses, lamps, or electron tubes.

*j. Overhaul.* Normally, the highest degree of maintenance performed by the Army in order to minimize time work in process is consistent with quality and economy of operation. It consists of that maintenance necessary to restore an item to completely serviceable condition as prescribed by maintenance standards in technical publications for each item of equipment. Overhaul normally does not return an item to like new, zero mileage, or zero hour condition.

*k. Rebuild.* The highest degree of material maintenance. It consists of restoring equipment as nearly as possible to new condition in accordance with original manufacturing standards. Rebuild is performed only when required by operational considerations or other paramount factors, and then only at the depot maintenance category. Rebuild reduces to zero the hours or miles the equipment, or component thereof, has been in use.

*l. Symbols.* The upper case letter placed in the appropriate column indicates the lowest level at which that particular maintenance function is to be performed.

**B-3. Explanation of Format**

*a. Column 1, Group Number.* Column 1 lists group numbers, the purpose of which is to identify components, assemblies, subassemblies, and modules with the next higher assembly.

*b. Column 2, Functional Group.* Column 2 lists the noun names of the components, assemblies sub-assemblies, and modules on which the maintenance is authorized.

*c. Column 3, Maintenance Functions.* Column 3 lists the maintenance category at which performance of the specific maintenance function is authorized. Authorization to perform a function at any category also includes authorization to perform that function at higher categories. The codes used represent the various maintenance categories as follows:

<i>Code</i>	<i>Maintenance category</i>
C.....	Operator/crew
O.....	Organizational maintenance
F.....	Direct support maintenance
H.....	General support maintenance
D.....	Depot maintenance

*d. Column 4, Tools and Test Equipment.* Column 4 specifies, by code, those tools and test equipment required to perform the designated function. The numbers appearing in this column refer to specific tools and test equipment which are identified in table I.

*e. Column 5, Remarks.* Self-explanatory.

**B-4. Explanation of Format of Table I, Tool and Test Equipment Requirements**

The columns in table I are as follows:

*a. Tools and Equipment.* The numbers in this column coincide with the numbers used in the tools and equipment column of the maintenance allocation chart. The numbers indicate the applicable tool for the maintenance function.

*b. Maintenance Category.* The codes in this column indicate the maintenance category normally allocated the facility.

*c. Nomenclature.* This column lists tools, test, and maintenance equipment required to perform the maintenance functions.

*d. Federal Stock Number.* This column lists the Federal stock number of the specific tool or test equipment.

*e. Tool Number.* Not used.

Section II. MAINTENANCE ALLOCATION CHART

GROUP NUMBER	COMPONENT ASSEMBLY NOMENCLATURE	MAINTENANCE FUNCTIONS											TOOLS AND EQUIPMENT	REMARKS	
		I N S P E C T	T E S T	S E R V I C E	A D J U S T	A L I G N	C A L I B R A T E	I N S T A L L	R E P L A C E	R E P A I R	O V E R H A U L	R E B U I L D			
1	TEST SETS, TELEGRAPH AN/GGH-15 (V)1 AND AN/GGM-15(V)2	C O		C O				O						8 8 1,2,3,4,5,6,7	Preventive Maintenance Preventive Maintenance Installation adjustments All adjustments Alarm Circuits
			o H		O H					O				1,2,3,4,5,6	All tests Lamps, fuses, P-C Boards All repairs except P-C Boards
							H							7 1,2,3,4,5,6,7,8 1,2,3,4,5,6,7	All calibrations
1A	PRINTED CIRCUIT BOARDS	O								O				1,2,3,4,5,6	
			H											7	

Table I. TOOL AND TEST EQUIPMENT REQUIREMENTS

TOOLS AND EQUIPMENT	MAINTENANCE CATEGORY	NOMENCLATURE	FEDERAL STOCK NUMBER	TOOL NUMBER
		AN/GGM-15(V)1, AN/GGM-15(V)2 (cont.)		
1	H,D	COUNTER, ELECTRONIC DIGITAL READOUT AN/USM-207	6625-911-6368	
2	H,D	GENERATOR, PULSE AN/UPM-15	6625-643-5969	
3	H,D	MULTIMETER, SN/PSM-6B	6625-957-4374	
4	H,D	OSCILLOSCOPE, AN/USM-281	6625-053-3112	
5	H,D	POWER SUPPLY, PP-3035/G	6130-823-3044	
6	O,H,D	POWER SUPPLY, PP-3941/G	6130-985-8143	
7	H,D	TOOL KIT, ELECTRONIC EQUIPMENT, TK-100/G	5180-605-0079	
8	O,H,D	TOOL KIT, ELECTRONIC EQUIPMENT, TK-105/G	5180-610-8177	

**APPENDIX C  
ORGANIZATIONAL REPAIR PARTS AND SPECIAL TOOL LISTS**

**Section I. INTRODUCTION**

**C-1. Scope**

This appendix contains a list of repair parts and special tools required for the performance of organizational maintenance for Test Sets, Telegraph AN/GGM-15(V)1 and AN/GGM-15(V)2.

**C-2. General**

This repair parts and special tools list is divided into four sections.

a. *Prescribed Load Allowance List (PLA), Section II.* The PLA is a consolidated listing of repair parts allocated for initial stockage at organizational maintenance level. This is a mandatory minimum stockage allowance.

b. *Special Tools, Test & Support Equipment for Organizational Maintenance, Section III.* Special tools, test equipment, and support equipment authorized for organizational maintenance is included in this section.

c. *Repair Parts for Organizational Maintenance, Section IV.* Repair parts authorized for organizational maintenance is included in this section.

d. *Federal Stock Number Cross-Reference Index, Section V.* This is a cross-reference index of Federal stock numbers to illustrations by figure and symbol number.

**C-3. Explanation of Columns**

An explanation of the columns in sections II through IV is given below.

a. *Source, Maintenance, and Recoverability Codes, Column 1, Sections III and IV.*

(1) *Source code, column 1a.* The selection status and source for the listed item is noted here. Source code and its explanation is as follows:

<i>Code</i>	<i>Explanation</i>
P .....	Applies to repair parts that are stocked in or supplied from the GSA/DSA, or Army supply system, and authorized for use at indicated maintenance categories.

(2) *Maintenance code, column 1b.* The lowest category of maintenance authorized to install the listed item is noted here.

<i>Code</i>	<i>Explanation</i>
O .....	Organizational maintenance

(3) *Recoverability code, column 1c.* The information in this column indicates whether unserviceable items should be returned for recovery or salvage. Recoverability codes and their explanations are as follows:

**NOTE**

When no code is indicated in the recoverability column, the part will be considered expendable.

<i>Code</i>	<i>Explanation</i>
R .....	Applies to repair parts and assemblies are economically repairable at DSU and GSU activities and normally are furnished by supply on an exchange basis.
T .....	Applies to high dollar value recoverable repair parts which are subject to special handling and are issued on an exchange basis. Such repair parts normally are repaired or overhauled at depot maintenance activities.
U .....	Applies to repair parts specifically selected for salvage by reclamation units because of precious metal content, critical materials, high dollar value reusable casings or castings.

b. *Federal Stock Number, Column 1, Section II, Column #, Sections III and IV.* The Federal stock number for the item is indicated in this column.

c. *Description, Column ,, Section II, Column a, Sections III and IV.* The model designator, sequence number, Federal item name, a five-digit manufacturer's code and a part number are included in this column. The designator (X) indicates the different models of the end equipment. For subsequent appearances of the same item, the manufacturer's code and part number are omitted. The words "same as" followed by the group or component heading when it first appeared on the list will follow the item name.

d. *Unit of Issue, Column 4, Sections III and IV.* The unit used as a basis of issue, e.g., ea, pr, ft, yd, etc., is indicated in this column.

e. *Quantity Incorporated in Unit Pack, Column 5, Sections III and IV.* The actual quantity contained in the unit pack is noted in this column.

f. *Quantity Incorporated in Unit, Column 6, Sections III and IV.* The quantity of repair parts in an assembly is given in this column. Subsequent appearances of the same item in the same assembly are indicated by the letters "REF".

g. *Maintenance Allowances (Col. X, Section II; Col. 7, Sections III and IV).*

(1) The allowance columns are divided into subcolumns. Indicated in each subcolumn opposite the first appearance of each item is the total quantity of items authorized for the number of equipments supported. Subsequent appearance of the same item will have no entry in the allowance columns but will have a reference in the description column to the first appearance of the item. Items authorized for use as required but not for initial stockage are identified with an asterisk in the allowance column.

(2) The quantitative allowance for organizational level of maintenance represents one initial prescribed load for a 15-day period for the number of equipments supported. Units and organizations authorized additional prescribed loads will multiply the number of prescribed loads authorized by the quantity of repair parts reflected in the appropriate density column to obtain the total quantity or repair parts authorized.

(3) Subsequent changes to organizational allowance will be limited as follows: No change in the range of items is authorized. If additional items are considered necessary, recommendation should be forwarded to the contracting officer for exception or revision to the allowance list. Revisions to the range of items authorized will be made based upon engineering experience, demand data, or TAERS information.

h. *Illustration, Column 8, Sections III and IV.*

(1) *Figure number, column 8a.* The number of the illustration in which the item is shown, and the maintenance-level suffix number of the technical manual in which the illustration appears is indicated in this column. *For example,* if the illustration in which the item is shown is figure 1-13 of the operator's manual (-10), the manual suffix -10 appears on the first line and the illustration number 1-13 on the second line. Refer only to those illustrations contained in the narrative and parts lists manuals on the same item of equipment as covered by this manual; that is, manuals with the same serial and FSC number.

(2) *Item or symbol number, column 8b.* The callout number used to reference the item in the illustration appears in this column.

**C-4. Location of Repair Parks**

a. When the Federal stock number is unknown, follow the procedure given in (1) through (4) below.

(1) Use the table of contents to determine the functional group or subgroup i.e., receiver, transmitter, electronic module, or assembly within which the repair part belongs.

(2) In the pertinent publication, find the repair part illustration covering the functional group or subgroup to which the repair part belongs.

(3) Locate the applicable illustration and note the figure number and item number.

(4) Use the repair parts listing to find the functional group or subgroup of the repair part and the figure number and item number as noted in the illustration.

b. When the Federal stock number is known, follow the procedures given in (1) and (2) below.

(1) Use the index of Federal stock numbers to figure and item numbers and locate the Federal stock number. The Federal stock numbers are listed in numerical sequence and are cross-referenced to the figure number and item number.

(2) Use the repair part listing to find the functional group or subgroup of the repair part and the figure and item number as noted in the index of Federal stock numbers.

**C-5. Federal Supply Codes**

This paragraph lists the Federal supply codes and the associated manufacturer's names.

<i>Code</i>	<i>Manufacturer</i>
08804 .....	General Electric Co., Lamp Metals and Components Dept. Cleveland Wire Plant, Cleveland Ohio.
14081 .....	Digitech Inc., Ridgefield, Conn.
49956 .....	Raytheon Company, Lexington, Mass.
75376 .....	Kurz-Kasch, Inc., Dayton, Ohio.
76915 .....	Littlefuse, Inc., Des Plaines, Ill.
90521 .....	Burroughs Corp., Cleveland, Ohio
96906 .....	Military Standards



SECTION II. PRESCRIBED LOAD ALLOWANCE LIST

PRESCRIBED LOAD ALLOWANCE						
(1) FEDERAL STOCK NUMBER	(2) DESCRIPTION	(3) 15 DAY ORG. MAINT. ALW.				(4) QTY INC IN UN PK
		1-5	6-20	21-50	51-100	
6625-4426135	OSCILLOSCOPE OS-206/(GM-15(V)					
5920-199-9498	A284 FUSE, CARTRIDGE: 75915; 313-500	3	8	20	38	1
5920-280-8344	A286 FUSE, CARTRIDGE: 75915; 312-500	2	5	13	25	1
5920-356-2185	A345 FUSE, CARTRIDGE: 75915; 312-100	3	10	25	47	1
5920-518-1790	A287 FUSE, CARTRIDGE: 75915; 312-375	2	5	13	25	1
6240-877-2811	A211 LAMP, INCANDESCENT: 08804; 1843	2	2	6	11	1
6240-892-4420	A140 LAMP, GLOW: 96906; MS25252NE2D	*	*	2	2	1
6625-443-5527	A079 CABLE ASSEMBLY, SPECIAL PURPOSE, BRANCHED: 80058; CX-12024/GGM-15(v)	*	*	*	2	12
6625-435-776	ANALYZER, SIGNAL DISTORTION TS- 2862/GGM 15(V)					
5920-295-9602	B320 FUSE, CARTRIDGE: 75915; 313001	2	4	1.	20	1
6240-722-6467	B171 LAMP, INCANDESCENT: 08804; 344	2	4	10	18	1
5960-497-9862	B221 NIXIE TUBE: 90521; B5750	*	2	2	2	1
6625-219-2525	GENERATOR, SIGNAL SG-860/GGM-15(V)					
5920-043-2641	C467 FUSE, CARTRIDGE: 75915; 312-250	2	4	11	20	1

SECTION III. SPECIAL TOOLS, TEST, AND SUPPORT EQUIPMENT FOR ORGANIZATIONAL MAINTENANCE

(1)			SECTION II. BASIC ISSUE ITEMS LIST						(4)	(5)	(6)	(7) 15 DAY ORG. MAINT. ALW.				(8) ILLUSTRATIONS			
(A) SRCE CD	(B) MNTC CD	(C) REC CD	(2) FEDERAL STOCK NUMBER	MODEL						(3) DESCRIPTION	UNIT OF ISSUE	QTY INC IN UN PK	QTY INC IN UNIT	(A) 1-5	(B) 6-20	(C) 21-50	(D) 51-100	(A) FIGURE NUMBER	(B) ITEM OR SYMBOL NUMBER
				1	2	3	4	5	6										
	O		6130-985-8143							POWER SUPPLY PP-3941/G	EA	1	1						
	O		5180-610-8177							TOOL KIT, ELECTRONIC EQUIPMENT TK-105/G	EA	1	1						

SECTION IV. REPAIR PARTS FOR ORGANIZATIONAL MAINTENANCE

(1)			(2) FEDERAL STOCK NUMBER	MODEL						(3) DESCRIPTION	(4) UNIT OF ISSUE	(5) QTY INC IN UN PK	(6) QTY INC IN UNIT	(7) 15 DAY ORG. MAINT. ALW.				(8) ILLUSTRATIONS	
(A) SRCE CD	(B) MNTC CD	(C) REC CD												(A) 1-5	(B) 6-20	(C) 21-50	(D) 51-100	(A) FIGURE NUMBER	(B) ITEM OR SYMBOL NUMBER
P	O													6625-443-5527					
			662S-442-6135							OSCILLOSCOPE OS-206/GG-15(V)									
P	0		6240-892-4420							A140 LAMP GLOW: 96906; MS25252NE2D	EA	1	1	*	*	2	2		3A1DS5
P	0		6240-877-2811							A211 LAMP, INCANDESCENT: 08804; 1843	EA	1	4	2	2	6	11		3A2DS1
P	0		6240-877-2811							A212 LAMP, INCANDESCENT: SAME AS A211	EA	1	REF						3A2DS2
P	0		6240-877-2811							A213 LAMP, INCANDESCENT: SAME AS A211	EA	1	REF						3A2DS3
P	0		6240-877-2811							A214 LAMP, INCANDESCENT: SAME AS A211	EA	1	REF						3A2DS4
P	0		5920-199-9498							A284 FUSE, CARTRIDGE: 75915; 313-500	EA	1	2	3	8	20	38	2-6	3A3F1
P	0		5920-199-9498							A285 FUSE, CARTRIDGE: SAME AS A284	EA	1	REF					2-6	3A3F2
P	0		5920-280-8344							A286 FUSE, CARTRIDGE: 75915; 312-500	EA	1	1	2	5	13	25	2-6	3A3F3
P	0		5920-5181790							A287 FUSE, CARTRIDGE: 75915; 312-375	EA	1	1	2	5	13	25	2-6	3A3F4
P	0		5920-356-2185							A345 FUSE, CARTRIDGE: 75915; 312-100	EA	1	2	3	10	25	47		3A3A2F1
P	0		5920-356-2185							A346 FUSE, CARTRIDGE: SAME AS A345	EA	1	REF						3A3A2F2

(1)			REPAIR PARTS FOR ORGANIZATIONAL MAINTENANCE						(4)	(5)	(6)	(7) 15 DAY ORG. MAINT. ALW.				(8) ILLUSTRATIONS			
(A) SRCE CD	(B) MNTC CD	(C) REC CD	(2) FEDERAL STOCK NUMBER	MODEL						(3) DESCRIPTION	UNIT OF ISSUE	QTY INC IN UN PK	QTY INC IN UNIT	(A) 1-5	(B) 6-20	(C) 21-50	(D) 51-100	(A) FIGURE NUMBER	(B) ITEM OR SYMBOL NUMBER
				1	2	3	4	5	6										
			6625-435-7776							ANALYZER, SIGNAL DISTORTION TS-2862/GGM-15(V)									
P	O		6240-722-6467							B171 LAMP, INCANDESCENT: 08804; 344	EA	1	5	2	3	7	13		2A1DS1
P	O		6240-722-6467							B172 LAMP, INCANDESCENT: SAME AS B171	EA	1	REF						2A1DS3
P	O		6240-722-6467							B173 LAMP, INCANDESCENT: SAME AS B171	EA	1	REF						2A1DS4
P	O		6240-722-6467							B174 LAMP, INCANDESCENT: SAME AS B171	EA	1	REF						2A1DS5
P	O		6240-722-6467							B175 LAMP, INCANDESCENT: SAME AS B171	EA	1	REF						2A1DS6
P	O		5960-497-9862							B221 NIXIE TUBE: 90521; B5750	EA	1	2	*	*	2	2		2A1A1V1
P	O		5960-497-9862							B222 NIXIE TUBE: SAME AS B241	EA	1	REF						2A1A1V2
P	O		5920-295-9602							B320 FUSE, CARTRIDGE: 75915; 313001	EA	1	2	2	4	11	20	2-5	2A2F1
P	O		5920-295-9602							B321 FUSE, CARTRIDGE: SAME AS B320	EA	1	REF					2-5	2A2F2
			6625-219-2525							GENERATOR, SIGNAL SG-86O/GGM-15(V)									
P	O		5920-43-2641							C467 FUSE, CARTRIDGE: 75915; 312-250	EA	1	2	2	4	11	20	2-4	1A2A2F1
P	O		5920-043-2641							C468 FUSE, CARTRIDGE: SAME AS C467	EA	1	REF					2-4	1A2A2F2

SECTION V. FEDERAL STOCK NUMBER CROSS-REFERENCE INDEX

Stock Number	Figure No.	Symbol No	Stock Number	Figure No.	Symbol No
5920-199-9498		3A3F1 3A3F2	6240-722-6467		2A1DS1 2A1DS3 2A1DS4 2A1DS6 2A1DS6
5920-043-2641		1A2A2F21 1A2A2F2			3A2DS1 3A2DS2 3A2DS3 3A2DS4
5920-280-8344		3A3F3	6240-877-2811		
5920-295-9602		2A2F1 2A2F2			
5920-356-2185		3A3A2F1 3A3A2F2	6240-892-4420		3A1DS5
5920-518-1790		3A3F4	6625-443-5527		6

By Order of the Secretary of the Army

W. C. WESTMORELAND,  
*General, United States Army,  
 Chief of Staff.*

Official:

KENNETH G. WICKHAM,  
*Major General, United States Army,  
 The Adjutant General.*

Distribution:

*Active Army:*

USASA (2)	USASTRATCOM-PAC (10)
CNGB (1)	USASTRATCOM-Sig Gp-T (10)
ACSC-E (2)	Instl (2) except
Dir of Trans (1)	Fort Gordon (10)
CofEngrs (1)	Fort Huachuca (10)
TSG (1)	WSMR (3)
CofSptS (1)	Fort Carson (25)
USAARENBD (2)	Army Dep (2) except
USAMB (10)	LBAD (14)
USACDC (2)	SAAD (80)
USACDC Agcy (1)	TOAD (14)
USAMC (1)	LEAD (7)
CONARC (5)	NAAD (5)
ARADCOM (2)	SVAD (5)
ARADCOM Rgn (2)	ATAD (10)
OS Maj Comd (4)	GENDEP (2)
USARYIS (5)	Sig Sec GENDEP (5)
LOGCOMDS (5)	Sig Dep (10)
USAMICOM (4)	SigFLDMS (2)
USATECOM (2)	ATS (1)
USASTRATCOM (4)	USAERDAA (2)
USAESC (70)	USAERDAW (5)
MDW (1)	USACRREL (2)
Armies (2)	MAAG (1)
Corps (2)	USARMIS (1)
1st Cav Div (3)	29th Sig Gp (5)
Svc Colleges (2)	1st Sig Bde (5)
USASESS (10)	USACOMZEUR (5)
USAADS (2)	Units org under fol TOE:
USAFAS (2)	(2 cys each unit)
USAARMS (2)	11-15 11-158
USAIS (2)	11-16 11-302
USAES (2)	11-18 11-327
USAINTS (3)	11-75 11-500(AA-AC)
WRAMC (1)	11-85 29-119
USACDCEC (10)	11-95 29-126
USASTRATCOM-CONUS (10)	11-97 29-134
USASTRATCOM-EUR (10)	11-117 29-136
USASTRATCOM-SO (10)	11-187
USASTRATCOM-A (5)	

NG: None

USAR: None

For explanation of abbreviations used, see AR 310-50.

RECOMMENDED CHANGES TO EQUIPMENT TECHNICAL PUBLICATIONS

 <div style="border: 1px solid black; border-radius: 15px; padding: 5px; display: inline-block; margin-left: 20px;"> <p style="margin: 0;"><i>THEN...JOT DOWN THE DOPE ABOUT IT ON THIS FORM. CAREFULLY TEAR IT OUT, FOLD IT AND DROP IT IN THE MAIL.</i></p> </div>		SOMETHING WRONG WITH PUBLICATION		
		FROM: (PRINT YOUR UNIT'S COMPLETE ADDRESS)		
PUBLICATION NUMBER		DATE SENT		
PUBLICATION DATE		PUBLICATION TITLE		
BE EXACT PIN-POINT WHERE IT IS				
PAGE NO.	PARA-GRAPH	FIGURE NO.	TABLE NO.	<p style="font-weight: bold; margin: 0;">IN THIS SPACE, TELL WHAT IS WRONG AND WHAT SHOULD BE DONE ABOUT IT.</p>
PRINTED NAME, GRADE OR TITLE AND TELEPHONE NUMBER			SIGN HERE	

